

ASSEMBLY AND MOUNTING INSTRUCTION

60-5653

Please read the Assembly Instruction sheet carefully before proceeding. Carefully unpack and identify all parts prior to building the unit. Each part is identified on the drawing for reference.

DO NOT DISCARD THE ORIGINAL PACKAGING. If after careful inspection and you must return the item for any reason. Please repack the unit using the original carton and inserts.

STEP 1: Unpack all the parts and classify them according to the illustration shown at the side. Place the parts on a scratch free surface.

STEP 2: Install the glass panels into the frame and fix it using the clips.

STEP 3: Install the correct bulbs (not provided).

STEP 4: Make sure the power is turned off at the wall outlet box where the fixture is to be installed. Secure the mounting bar to the wall Junction box using the mounting screws.

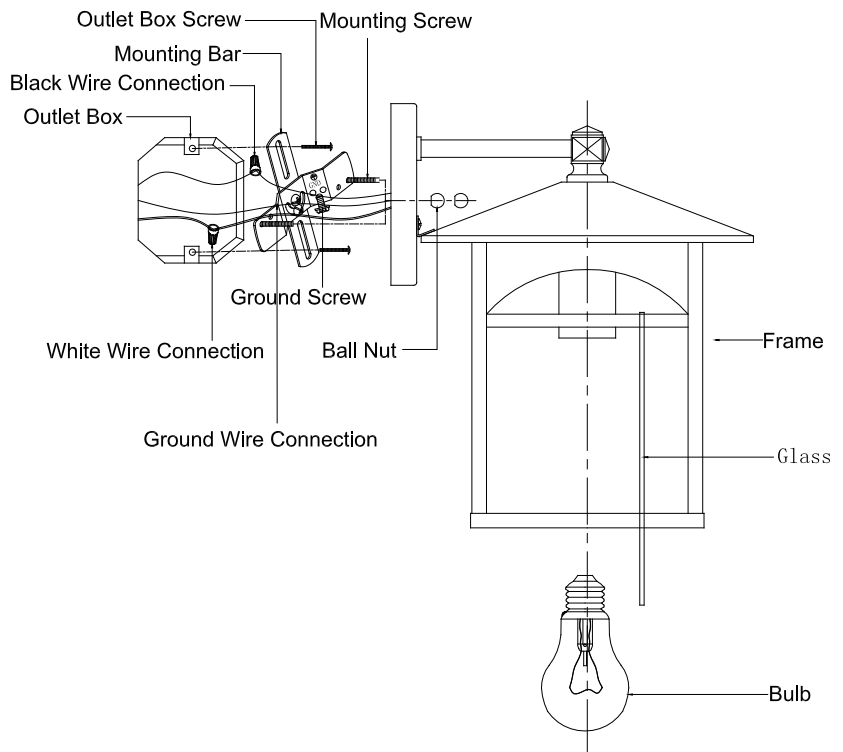

STEP 5: Use the wire connection to connect the positive and neutral wires. Connect the Ground wire to the junction box ground port.

STEP 6: Secure the fixture to the wall outlet box using two ball nut.

Turn on the power at fuse or circuit box

CAUTION:

To reduce the risk of fire, use the specified lamp wattage (or smaller) and bulb type identified on the product.

CLEANING INSTRUCTIONS:

Do not use polish or cleaners on your product. Just wipe clean with a soft cloth.

CAUTION----RISK OF FIRE

This product requires installation by a qualified electrician. Before installing be sure to read all instructions and **TURN THE POWER TO THE ELECTRICAL JUNCTION BOX OFF.**