

A-A

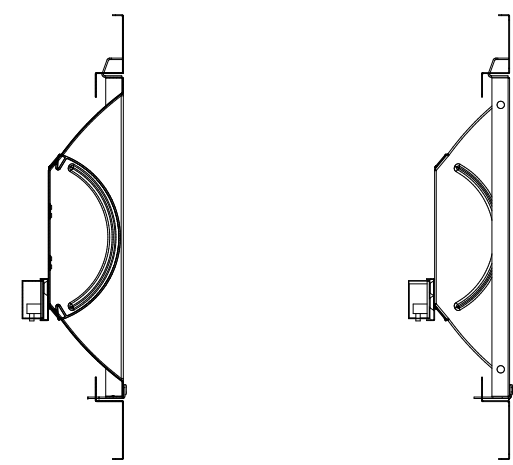

B-B

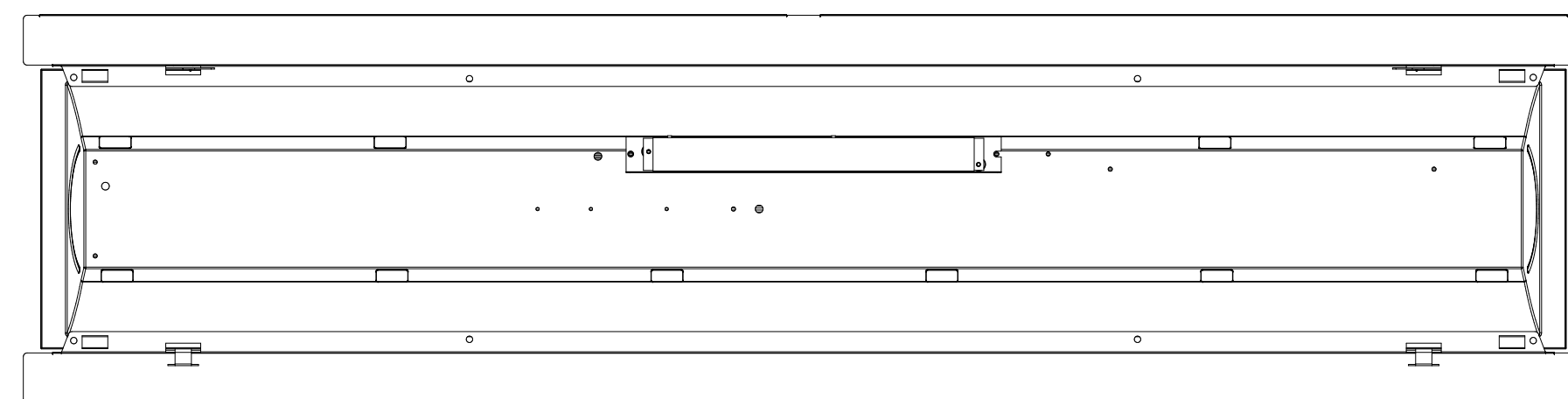
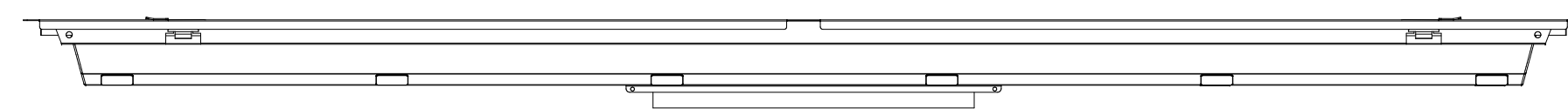
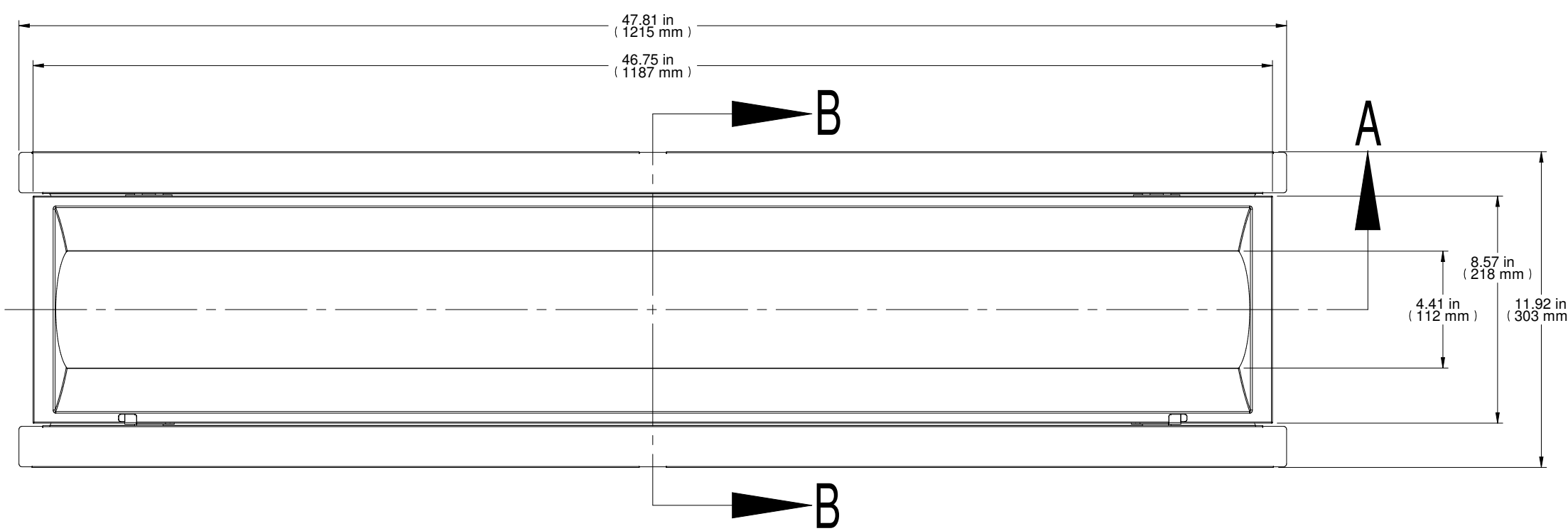
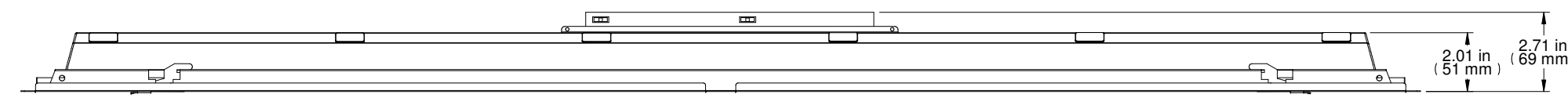
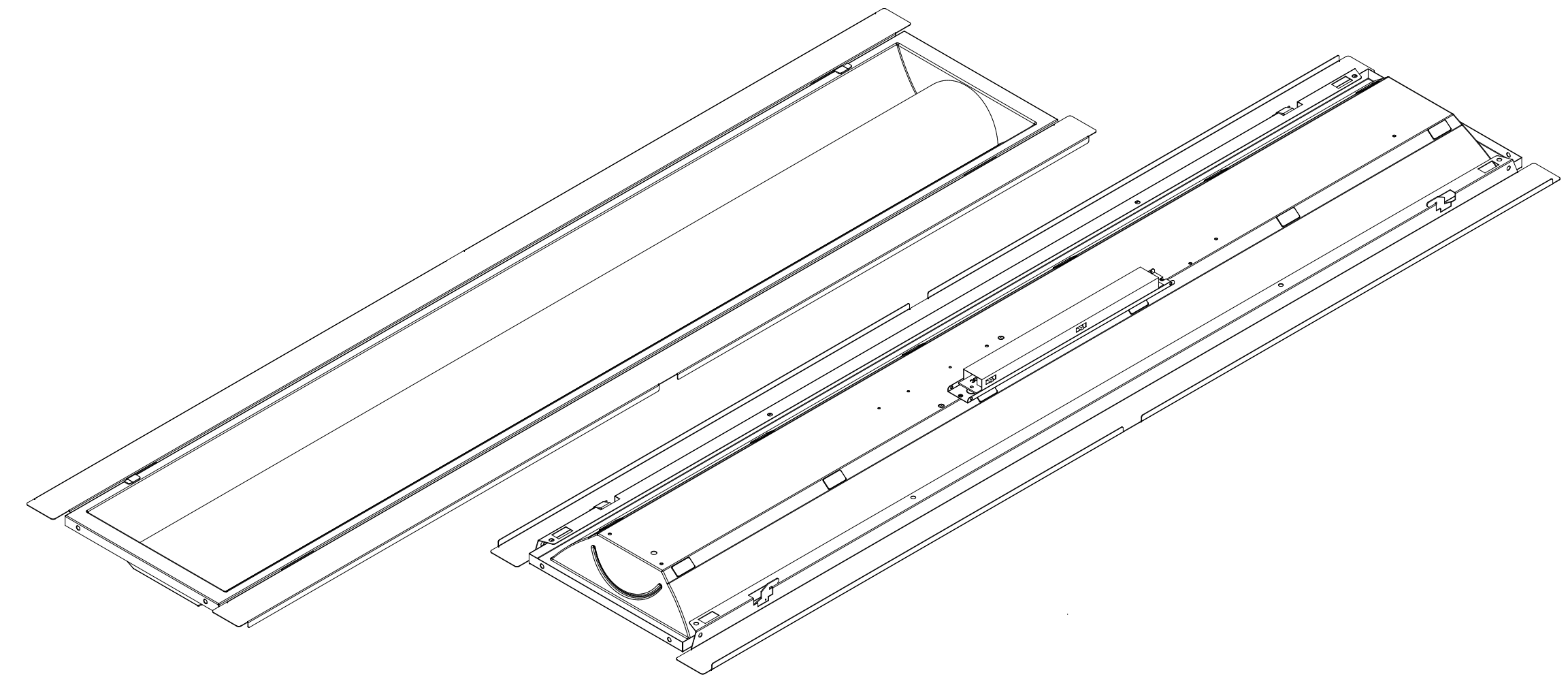

Minimum Housing Dimensions

This retrofit kit was designed to upgrade recessed 1x4 fixtures, including most parabolic and lensed troffers from all major manufacturers. Dimensional requirements are shown below, but Satco recommends a test installation prior to purchasing full project quantities.

