

TOP

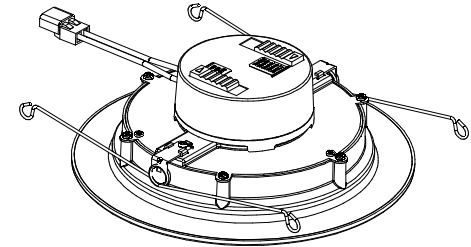

TOP ISOMETRIC

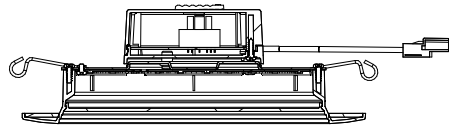

SECTION A-A

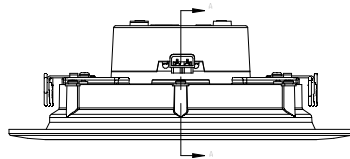

LEFT

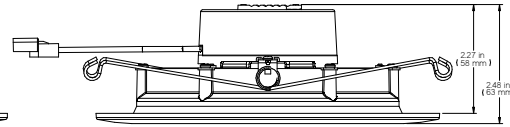

FRONT

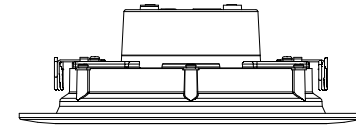

RIGHT

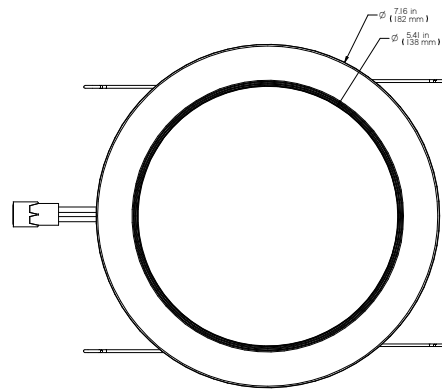

BOTTOM

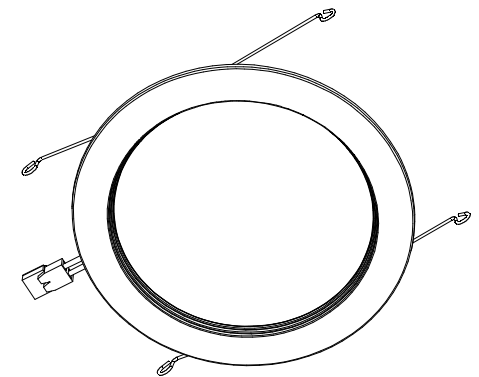

BOTTOM ISOMETRIC

SATCO ITEM: S11897