



The SMART home lighting and control ecosystem created to enrich your quality of life through convenience and connection.



STARFISH®



STARFISH[®]



STARFISH IS MORE THAN LIGHT CONTROL IT IS AN IMMERSIVE EXPERIENCE

COMPLETE SMART HOME ECOSYSTEM SOLUTION

STARFISH® Smart products connects life and home together helping to enhance convenience, security, atmosphere and wellness. Synchronize your mobile and voice activated devices to connect anywhere, anytime. It's easy and convenient; no hub required.



BUILD SCENES & SET ATMOSPHERE

Dynamic scene setting with millions of colors can create, change and set the right atmosphere.



CREATE SCHEDULES

Set up the home to transition with daily activities. Schedule light for home and away, or use voice activation in emergencies.



ENSURE SECURITY & SAFETY

Add that extra layer of security with our Indoor & Outdoor Video Cameras and Doorbells.



ENHANCE WELLNESS

Set lighting to follow the natural daylight and seasonal patterns for positivity.



remote access



multi-user



voice control



set routines



create schedules



build scenes



geofencing



EXPLORE STARFISH ONLINE!

For an in-depth exploration of STARFISH features including the latest products, visit our website. FAQs, How-To videos, the latest news and more! STARFISH offers screen recordings to guide users through common setup and features.

SATCOSTARFISH.COM

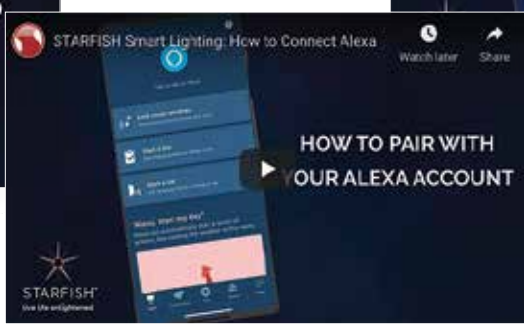



STARFISH®
live life enlightened

SMART CONTROLS ANYWHERE, ANYTIME



DOWNLOAD
The free
STARFISH APP



PAIR DEVICE
Smart products and
configure settings



CUSTOMIZE
Colors, scenes and
special effects



CONTROL
Monitor
all devices



Choose Dark Mode
or Light Mode



**NO MONTHLY
SUBSCRIPTION**



STARFISH®
live life enlightened

LOGIN

REGISTER YOUR DEVICE





TABLE OF CONTENTS

Control Panels	8-9
Color Changing Bulbs	10-15
Color Changing Decorative Ribbon Bulbs.....	16-19
Color Changing Slim and Low Profile Downlights with Remote Driver	20-23
Color Changing Retrofit Downlights	24-25
Color Changing Track Heads.....	26-27
Lacey Collection - Color Changing Pendants.....	28-29
Security Light & Camera	30-33
Video Doorbells	34-35
Indoor and Outdoor Cameras	36-37
Color Changing Under Cabinet Fixtures.....	38-39
DIMENSION Tape Light Kits.....	40-43
Color Changing String Lights.....	44-45
Color Changing Eave Lights	46-47
Color Changing Landscape Flood Lights.....	48-49
Color Changing Outdoor Lanterns.....	50-51
Programmable Remote.....	52-53
Plugs, Switches and Receptacle.....	54-55

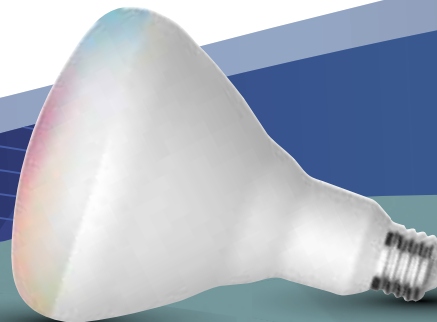

SMART CONTROL PANELS

Upgrade your Smart Home with the addition of SATCO's Smart Control Panels with STARFISH technology. STARFISH Control Panels can become the command center of your home to control all smart lighting, view live video from your doorbell and security cameras, use as intercoms, and have an easy view of the time, date, weather and humidity conditions. Although controlling STARFISH products from your mobile device is convenient, this makes it easy for guests, relatives, and kids to adjust the ambiance of their space from one central location without having full access to the STARFISH APP.



*Smart Control Panels must be paired and bound to STARFISH account before use. All devices in STARFISH account then upload into Smart Panel.

FEATURES



Anti-fingerprint coated screen



5" model fits in single gang junction box



10" model features flexible installation in single through quad gang junction boxes



10" model includes assignable buttons



Installation screws and reset pin Included



Available in
5" or 10" panels



STARFISH Command Center For Your Home or Business

- In-wall wired smart touch screen - neutral wire required
- Available in 5" or 10" panels
- Hardwired installation replaces existing wall switch in up to 4-gang wall box
- Receives latest features and enhancements via OTA updates
- Built-In Alexa, Zigbee Hub and Bluetooth Hub (no hub required for STARFISH ecosystem)
- Control lights, music, cameras, scenes, etc.



Download
Spec Sheet



WIFI
2.4GHz
No Hub Required



ITEM SPECIFICATIONS / ORDER INFO

Item	Size	Voltage	Screen Resolution	Speakers	Integrated Camera	Assignable Buttons
S11575	5"	120V-240V	480 x 854	1	No	N/A
S11576	10"	120V-240V	1920 x 1200	2	Yes	Yes

SMART COLOR CHANGING BULBS

Customizable lighting with style and ease. Delivering 90 CRI color accuracy, tunable white light (2700K-5000K) and millions of RGB colors to create the perfect ambiance. Enclosed fixture rated with dimming controlled exclusively through the STARFISH APP. Backed by a 3-year, 25,000-hour warranty combining smart technology with lasting performance.

FEATURES

- RGB Color-Changing and Tunable White 2700K-5000K
- Advanced Pairing Technology - For Pairing Multiple Lights
- Enclosed Fixture Rated
- Dimmable with STARFISH APP
- Pre-set and Custom Color-Changing Effects
- High Color Rendering 90 CRI
- Residential, Multi-Family, Hospitality, Retail, Commercial

WIFI 
2.4GHz
No Hub Required



A19 & A21 General Household

Delivering 90 CRI color accuracy, tunable white light (2700K-5000K) and millions of RGB colors to create the perfect ambiance in any room. Enclosed fixture rated with dimming and color selection controlled exclusively through the STARFISH APP.

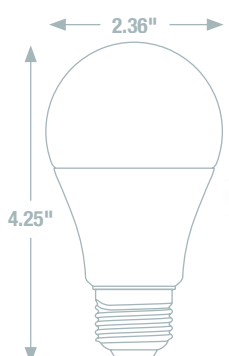

S11100

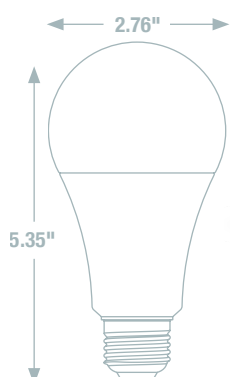

S11101

Download Spec Sheet



ITEM SPECIFICATIONS / ORDER INFO

Item	Lamp Shape	Lamp Base	Wattage	Replacement Wattage	Lumens	Input Current	Input Voltage/Frequency	Location Rating	Beam Angle	THD	CCT
S11100	A19	Medium E26	10W	60W	800	0.09A	120V, 60Hz	Damp	220°	14.75%	2700K-5000K
S11101	A21	Medium E26	13W	75W	1100	0.12A	120V, 60Hz	Damp	220°	14.84%	2700K-5000K

SMART COLOR CHANGING BULBS

B11 Torpedo and G25 Globe

G25 globes are perfect for vanity lights in bathrooms and makeup areas, while the B11 Torpedo's are great for decorative accent lighting in various indoor settings like bedrooms, dining rooms, restaurants, and for exposed-bulb fixtures. Use the STARFISH APP to dim and create the perfect ambiance.



Download
Spec Sheet



ITEM SPECIFICATIONS / ORDER INFO



Item	Lamp Shape	Lamp Base	Wattage	Replacement Wattage	Lumens	Input Current	Input Voltage/Frequency	Location Rating	Beam Angle	THD	CCT
S11102	G25	Medium E26	10W	60W	800	0.09A	120V, 60Hz	Damp	320°	16.64%	2700K-5000K
S11111	B11	Candelabra E12	5.5W	40W	500	0.07A	120V, 60Hz	Damp	180°	-	2700K-5000K
S11112	B11	Medium E26	5.5W	40W	500	0.07A	120V, 60Hz	Damp	180°	-	2700K-5000K

MR16 Mini Reflector

Use for directional lighting in applications like track lighting, recessed fixtures, and spotlighting to illuminate specific areas in both residential and commercial settings. Advanced pairing allows you to pair multiple lamps all at once.



Download Spec Sheet



ITEM SPECIFICATIONS / ORDER INFO

Item	Lamp Shape	Lamp Base	Wattage	Replacement Wattage	Lumens	Input Current	Input Voltage/ Frequency	Location Rating	Beam Angle	THD	CCT
S1109	GU10	Bi-pin	5.5W	35W	400	0.05A	120V, 60Hz	Damp	50°	20.01%	2700K-5000K
S1110	GU5.3	Bi-pin	5.5W	35W	400	0.46A	12V, 60Hz	Damp	50°	<20%	2700K-5000K

SMART COLOR CHANGING BULBS

R20, BR30 & BR40 Indoor Reflectors

Used as a versatile and powerful light source in various indoor settings. Ideal for general and flood lighting in larger spaces, such as high ceilings, open-plan living rooms, and commercial areas like retail stores and warehouses. Provides wide, even illumination.



Download Spec Sheet



ITEM SPECIFICATIONS / ORDER INFO

Item	Lamp Shape	Lamp Base	Wattage	Replacement Wattage	Lumens	Input Current	Input Voltage/Frequency	Location Rating	Beam Angle	THD	CCT
S11103	R20	Medium E26	6W	45W	480	0.06A	120V, 60Hz	Damp	110°	21.77%	2700K-5000K
S11104	BR30	Medium E26	9.5W	60W	800	0.09A	120V, 60Hz	Damp	110°	13.09%	2700K-5000K
S11105	BR40	Medium E26	12W	70W	960	0.11A	120V, 60Hz	Damp	110°	16.41%	2700K-5000K

PAR20, PAR30, PAR38 Indoor/Outdoor Flood Lights

Provides wide, even illumination in large areas outdoors, providing safety and visibility in yards, driveways and parking lots.



Download Spec Sheet



- ADVANCED PAIRING
- 90 CRI
- DIMMABLE WITH APP
- WET LOCATION
- 3 YEAR WARRANTY
- ENCLOSED FIXTURE
- 25,000 HOURS
- Tunable White
- RGB Color

ITEM SPECIFICATIONS / ORDER INFO

Item	Lamp Shape	Lamp Base	Wattage	Replacement Wattage	Lumens	Input Current	Input Voltage/Frequency	Location Rating	Beam Angle	THD	CCT
S11106	PAR20	Medium E26	5.5W	40W	500	0.05A	120V, 60Hz	Wet	40°	15.75%	2700K-5000K
S11107	PAR30	Medium E26	12.5W	70W	1000	0.12A	120V, 60Hz	Wet	40°	14.30%	2700K-5000K
S11108	PAR38	Medium E26	15W	80W	1200	0.14A	120V, 60Hz	Wet	40°	13.38%	2700K-5000K

SMART COLOR CHANGING DECORATIVE RIBBON BULBS

Featuring an eye-catching RGBTW decorative ribbon filament that is beautifully showcased through the clear glass bulb. Available in A19, ST19, Tubular and B11 Candelabra bulb types with both medium E26 and a candelabra E12 base, these bulbs offer flexibility for a range of fixtures. With tunable white options from a warm 2700K to a crisp 5000K and access to millions of vibrant RGB colors, they create the perfect ambiance for any space. Fully dimmable and controlled via the STARFISH APP, users can easily customize lighting scenes and enjoy dynamic color effects. These bulbs seamlessly blend classic design with modern Smart capabilities.

FEATURES

- RGB Color-Changing and Tunable White 2700K-5000K
- Decorative Ribbon Filament
- Advanced Pairing Technology - Pairing Multiple Lights
- Enclosed Fixture Rated
- Dimmable with STARFISH APP
- Pre-set and Custom Color-Changing Effects
- Residential, Multi-Family, Hospitality, Retail, Commercial



STARFISH Quick Tip

Watch a video about creating a Group to control multiple lights with the tap of a button



WIFI
2.4GHz
No Hub Required



ST19 and Tubular Decorative Household

This vintage-style, pear-shaped bulb is used for decorative and ambient lighting in visible fixtures like pendant lights, chandeliers, and wall sconces to provide a classic Edison-style aesthetic while using modern, energy-efficient LED technology.



S11244



S11245



S11246

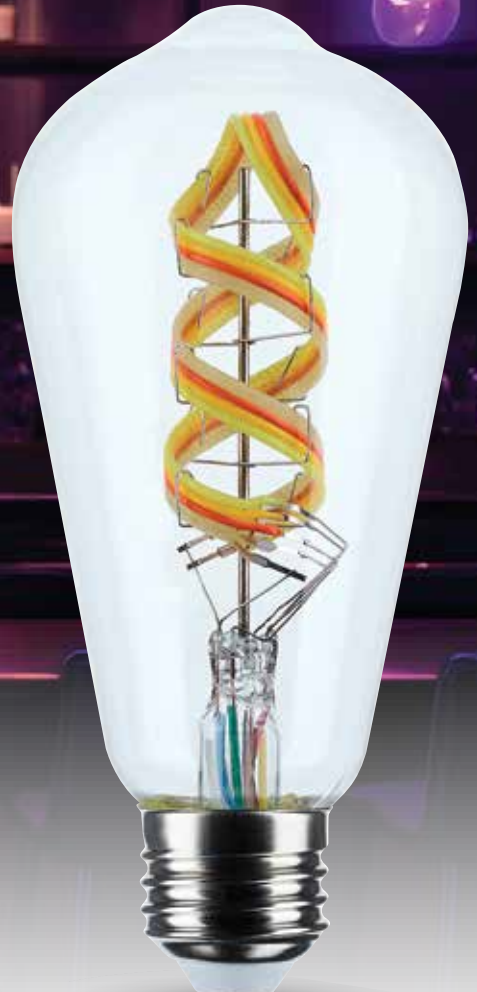

S11240

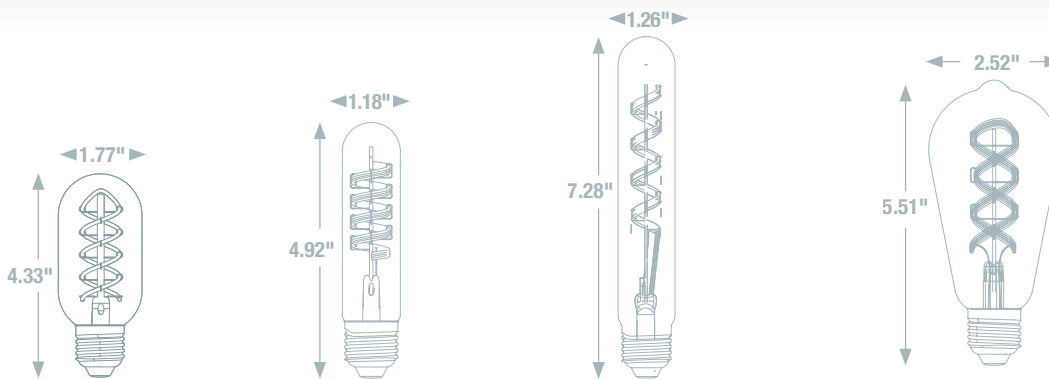

Download Spec Sheet



ITEM SPECIFICATIONS / ORDER INFO

Item	Lamp Shape	Lamp Base	Wattage	Replacement Wattage	Lumens	Input Current	Input Voltage/Frequency	Location Rating	Beam Angle	THD	CCT
S11240	ST19	Medium E26	6W	40W	450	0.08A	120V, 60Hz	Damp	320°	89.20%	2700K-5000K
S11244	T14	Medium E26	5.5W	40W	450	0.065A	120V, 60Hz	Damp	320°	-	2700K-5000K
S11245	T10	Medium E26	5.5W	40W	450	0.065A	120V, 60Hz	Damp	320°	-	2700K-5000K
S11246	T9	Medium E26	5.5W	40W	450	0.065A	120V, 60Hz	Damp	320°	-	2700K-5000K

SMART COLOR CHANGING DECORATIVE RIBBON BULBS

A19 General Household

Decorative A19 lamps offer both aesthetic and functional benefits, such as enhancing a room's decor, improving energy efficiency, and creating a customized ambiance. It's unique design can become a focal point or a statement piece in a room.

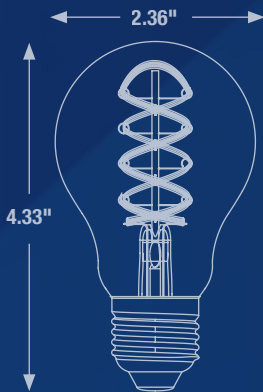

S11241

Decorative Ribbon Filament

Choose from millions of colors and tunable warm to natural light



Download
Spec Sheet



ITEM SPECIFICATIONS / ORDER INFO



Item	Lamp Shape	Lamp Base	Wattage	Replacement Wattage	Lumens	Input Current	Input Voltage/ Frequency	Location Rating	Beam Angle	THD	CCT
S11241	A19	Medium E26	6W	40W	450	0.08A	120V, 60Hz	Damp	320°	89.20%	2700K-5000K

B11 Torpedo

Create an elegant aesthetic for decorative fixtures like chandeliers and sconces. Specifically designed to enhance the look of decorative fixtures and dimmable with the STARFISH APP.



ITEM SPECIFICATIONS / ORDER INFO



Item	Lamp Shape	Lamp Base	Wattage	Replacement Wattage	Lumens	Input Current	Input Voltage/ Frequency	Location Rating	Beam Angle	THD	CCT
S11242	B11	Candelabra E12	4W	40W	300	0.05A	120V, 60Hz	Damp	320°	92.30%	2700K-5000K
S11243	B11	Medium E26	4W	40W	300	0.05A	120V, 60Hz	Damp	320°	92.30%	2700K-5000K

SMART COLOR CHANGING SLIM AND LOW PROFILE DOWNLIGHTS WITH REMOTE DRIVER

The ultimate choice for smart lighting and ambiance control. Download the STARFISH APP to customize any tunable white color temperatures from warm to natural light, or choose from millions of colors on the RGB spectrum, all from your mobile device. The Directional model features 360° rotation and 0° to 80° tilt allowing for the light to be focused where it's needed most. Our round and square remote driver downlights are available in a sleek flat lens or a smooth baffle to reduce glare. These slimfit downlights are ideal for transforming residential and multi-family environments.

FEATURES

- RGB Color-Changing and Tunable White
- 4" and 6" Sizes
- Advanced Pairing Technology
- Available in Round and Square
- Smooth Baffle Models Reduce Glare
- Dimmable with STARFISH APP
- IC Rated
- Pre-set and Custom Color-Changing Effects
- Residential, Multi-Family, Hospitality, Retail, Commercial



STARFISH® Quick Tip

Watch a video about creating a Room using the STARFISH APP



WIFI
2.4GHz



No Hub Required



Round - Flat Lens and Smooth Baffle

Slimfit Downlights with STARFISH technology are the ultimate choice for Smart lighting and ambiance control. Customize any tunable white color temperatures from 2000K warm white to 5000K natural light or choose from millions of colors on the RGB spectrum, ideal for transforming residential and multi-family environments.

Remote Driver J-Box
For direct wire installation

Low Profile Design

Spring Clips
Installation for ceilings up to 1" thick

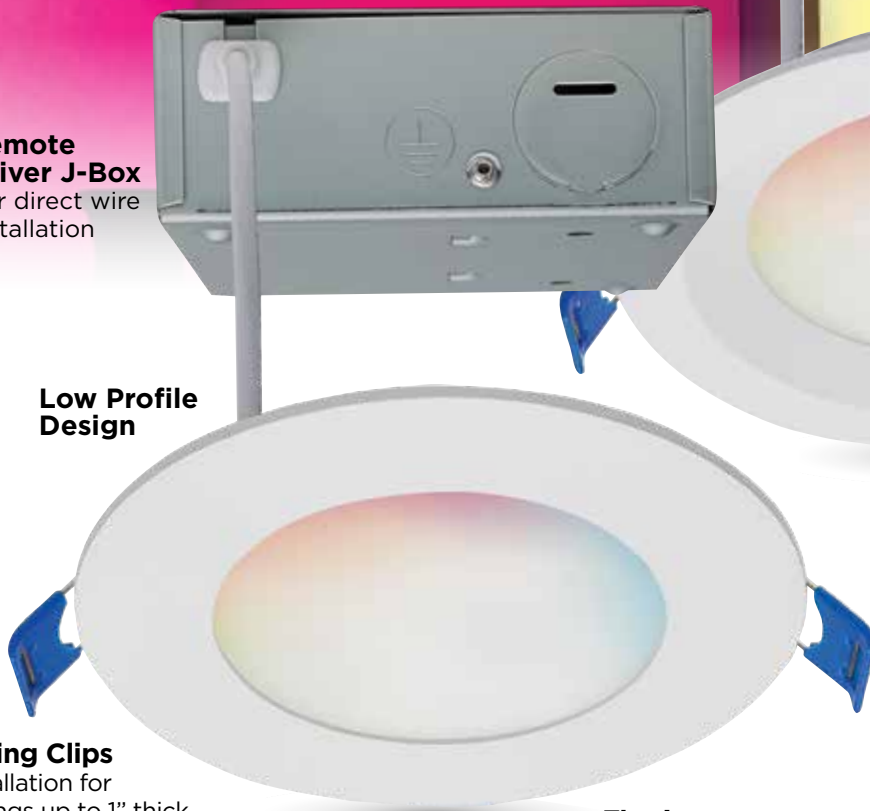

Flat Lens
S11560

Smooth Baffle
S11564

Download a Spec Sheet which includes a Complete List of Accessories



ITEM SPECIFICATIONS / ORDER INFO



Item	Type	Size	Finish Color	Wattage	Replacement Wattage	Lumens	Volts	CCT
S11560	Flat Lens	4"	White	9W	45W	540	120V	2000K-5000K
S11562	Flat Lens	6"	White	12W	60W	750	120V	2000K-5000K
S11564	Smooth Baffle	4"	White	9W	45W	540	120V	2000K-5000K
S11566	Smooth Baffle	6"	White	12W	60W	750	120V	2000K-5000K
S11636	Flat Lens	4"	White	8W	50W	650	120V	2000K-5000K
S11637	Flat Lens	6"	White	11W	70W	900	120V	2000K-5000K

SMART COLOR CHANGING SLIM AND LOW PROFILE DOWNLIGHTS WITH REMOTE DRIVER

Square - Flat Lens and Smooth Baffle

Offered with flat lens, or a smooth baffle to reduce glare. These downlights are also compatible with Siri, Alexa, Google Home, and SmartThings so they can be easily incorporated into your Smart home.

WIFI
2.4GHz
No Hub Required



Flat Lens
S11563

Smooth Baffle
S11565



Download
Spec Sheet



ITEM SPECIFICATIONS / ORDER INFO



Item	Type	Size	Finish Color	Wattage	Replacement Wattage	Lumens	Volts	CCT
S11561	Flat Lens	4"	White	9W	45W	540	120V	2000K-5000K
S11563	Flat Lens	6"	White	12W	60W	750	120V	2000K-5000K
S11565	Smooth Baffle	4"	White	9W	45W	540	120V	2000K-5000K
S11567	Smooth Baffle	6"	White	12W	60W	750	120V	2000K-5000K

Round - Directional Downlight with Remote Driver

The ultimate choice for Smart lighting and ambiance control. Customize any tunable white color temperatures from 2700K warm white light to 5000K natural light, or choose from millions of colors on the RGB spectrum, all from your mobile device. The 360° rotation and 0° to 80° tilt allow for the light to be positioned as needed, focusing light where it's needed most.



S11296R1

S11295R1

WIFI 
2.4GHz
No Hub Required

Download
Spec Sheet



ITEM SPECIFICATIONS / ORDER INFO



Item	Size	Finish Color	Wattage	Replacement Wattage	Lumens	Volts	CCT
S11293R1	4"	White	9W	50W	750	120V-277V	2700K-5000K
S11294R1	4"	Black	9W	50W	750	120V-277V	2700K-5000K
S11295R1	6"	White	15W	75W	1250	120V-277V	2700K-5000K
S11296R1	6"	Black	15W	75W	1250	120V-277V	2700K-5000K

SMART COLOR CHANGING RETROFIT DOWNLIGHTS

The ultimate choice for smart lighting and ambiance control. Download the STARFISH APP to customize any tunable white color temperatures from 2000K warm white light to 5000K natural light, or choose from millions of colors on the RGB spectrum, all from your mobile device. Our Stepped or Smooth Baffle trims offer added dimension while reducing glare.

FEATURES

- RGB Color-Changing and Tunable White 2000K-5000K
- 4" and 6" Sizes
- Available in Round and Square
- E26 Adapter Included
- Stepped Baffle Reduces Glare
- Advanced Pairing Technology
- Dimmable with STARFISH APP
- Pre-set and Custom Color-Changing Effects
- Residential, Multi-Family, Hospitality, Retail, Commercial



STARFISH Quick Tip

Watch a video about creating and controlling a Room Group using the STARFISH APP



WIFI 
2.4GHz
No Hub Required



Smooth Baffle
S11638

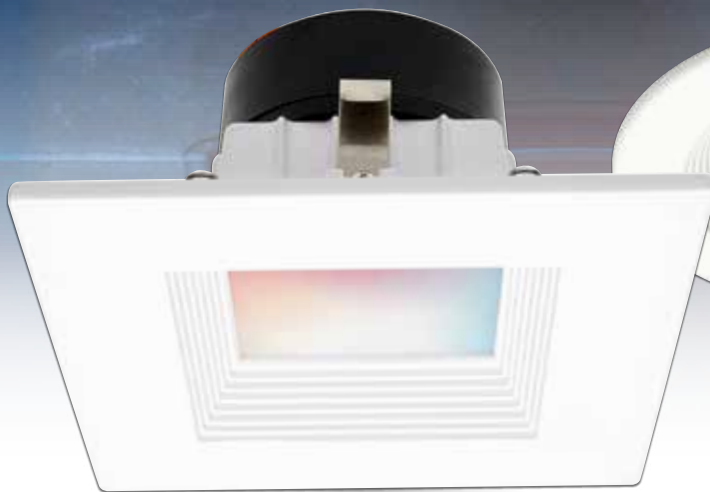

Stepped Baffle
S11569

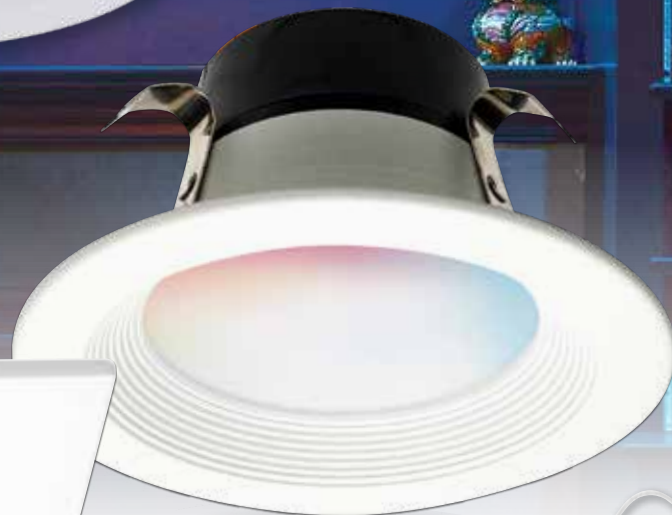

Stepped Baffle
S11568



E26 Adapter Included

Download
Spec Sheet



Stepped Baffle



Item	Shape	Size	Finish Color	Wattage	Replacement Wattage	Lumens	Volts	CCT
S11568	Round	4"	White	10.5W	50W	650	120V	2000K-5000K
S11569	Square	4"	White	10.5W	50W	650	120V	2000K-5000K
S11570	Round	6"	White	13W	65W	850	120V	2000K-5000K
S11571	Square	6"	White	13W	65W	850	120V	2000K-5000K

Download
Spec Sheet



Smooth Baffle



Item	Shape	Size	Finish Color	Wattage	Replacement Wattage	Lumens	Volts	CCT
S11638	Round	4"	White	8W	50W	650	120V	2000K-5000K
S11639	Round	6"	White	11W	70W	900	120V	2000K-5000K

SMART COLOR CHANGING TRACK HEADS

Available in round or pinch-back shapes, and offered in sleek black or white finishes, these track heads boast adjustability, enabling you to pivot per your lighting requirements. Experience vibrant hues, seamless control, and enchanting lighting effects tailored to your unique style and preferences with these Smart track fixtures.

FEATURES

- RGB Color-Changing and Tunable White 2000K-5000K
- Compatible with Single Circuit H-Track Systems
- Contemporary Design with Intelligent Lighting
- Adjustable Die-Cast Aluminum Track Head
- Advanced Pairing Technology
- Dimmable with STARFISH APP
- Pre-set and Custom Color-Changing Effects
- Showrooms, Retail, Hospitality, Commercial, Residential, Multi-Family



STARFISH Quick Tip

Watch a video about rearranging and hiding devices using the STARFISH APP



WIFI

2.4GHz



No Hub Required



Download Spec Sheet



ITEM SPECIFICATIONS / ORDER INFO

Item	Shape	Finish Color	Wattage	Inc. Replacement Wattage	Lumens	Volts	CCT
TH903	Round	Matte White	12W	60W	1100	120V	2000K-5000K
TH904	Round	Matte Black	12W	60W	1100	120V	2000K-5000K
TH913	Pinch Back	Matte White	12W	60W	1100	120V	2000K-5000K
TH914	Pinch Back	Matte Black	12W	60W	1100	120V	2000K-5000K

OPTIONAL ACCESSORIES (SOLD SEPARATELY)

Item	Description
TP176	Square Offset Monopoint - White Finish
TP177	Square Offset Monopoint - Black Finish



Download a Complete Listing of Track Accessories



LACEY COLLECTION – SMART COLOR CHANGING PENDANTS

Sophisticated design with the advanced functionality of STARFISH Smart technology our elegant lead free bubble crystal fixtures create a stunning interplay of light, texture, and color. Each bubble sparkles with vibrant hues, while traditional white tones, ranging from warm to natural light, offer a more classic lighting option. Matte black accents enhance the crystal's brilliance, elevating your home with an artistic touch that merges luxury and modern style. Easily adjust settings and customize your space using the STARFISH APP.

FEATURES

- RGB Color-Changing and Tunable White 2000K-5000K
- Available in Three Pendant Styles
- Features Lead Free Bubble Crystal
- Advanced Pairing Technology
- Dimmable with STARFISH APP
- Pre-set and Custom Color-Changing Effects
- Showrooms, Retail, Hospitality, Commercial, Residential, Multi-Family



STARFISH® Quick Tip

*Watch a video about
adjusting power outage
settings using the
STARFISH APP*



WIFI

2.4GHz

No Hub Required

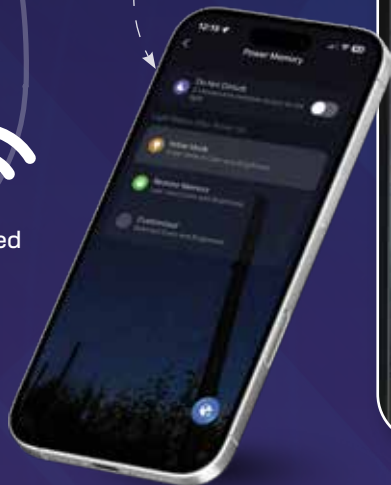

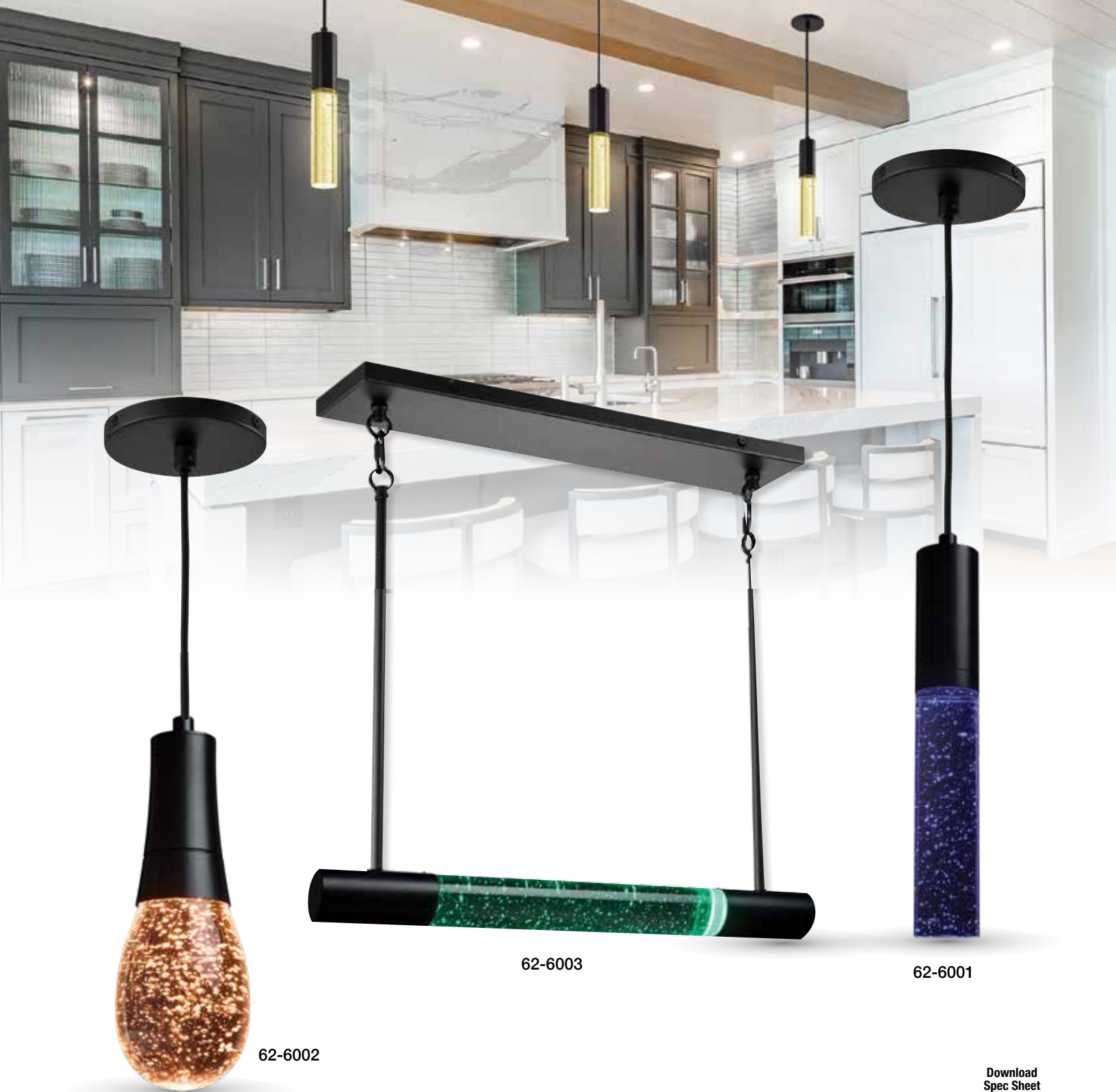

62-6003

62-6001

62-6002

Download
Spec Sheet



ITEM SPECIFICATIONS / ORDER INFO

Item	Description	Wattage	Replacement Wattage	Lumens	CCT	Volts	Wire Length	Max Rod Length
62-6001	4" Pendant - Matte Black with K9 Bubble Crystal	11.5W	75W	1100	2000K-5000K	120V	144"	-
62-6002	2" Mini Pendant - Matte Black with K9 Bubble Crystal	11.5W	75W	1100	2000K-5000K	120V	144"	-
62-6003	23" LED Island Pendant with K9 Bubble Crystal	11.5W	75W	1100	2000K-5000K	120V	144"	36" (Comes with Four 6" Stems and Four 12" Stems)

SMART SECURITY LIGHT & CAMERA

The next evolution in smart security devices - SATCO's Security Floodlight Cameras powered by STARFISH, provides the latest technology in home security and surveillance **WITHOUT** the monthly subscription fees. Video is stored directly to the local microSD card, eliminating the concern of cloud data breaches and camera hacking. Instantly view all recorded events seamlessly on your mobile device anywhere, any time!

FEATURES

- Adjustable High Lumen Heads and Camera
- Advanced Motion Detection with Adjustable Motion Zones and Sensitivity of Real-Time Motion Events
- IR Night Vision with Integrated Security Alarm
- Remote Viewing, Two-Way Talk
- HD Video Camera with Wide Viewing Angle
- Local Storage, 32GB SD Card Included - Expandable to 128GB
- Wireless Control Using the STARFISH APP
- Wet Location IP65 Rated

STARFISH Quick Tip

Watch a video about remote viewing and two-way talk using the STARFISH APP



APP also features alarm, setting PIR zones and area, light control and adjustable speaker volume.

**— NO —
MONTHLY
SUBSCRIPTION**
32 GB MICRO SD CARD INCLUDED

WIFI
2.4GHz
No Hub Required

2-way talk

remote access

night vision

AWS secure encryption

dimmable with APP

alarm



NO MONTHLY SUBSCRIPTION
Access video content on included 32GB microSD Card (expandable to 128GB)



REAL-TIME MOTION EVENTS
Get real-time notifications when motion is detected around your home



VIDEO HISTORY
Check your motion recording history to see activity while you're away

AWS Cloud Servers utilize the latest encryption technology to keep your information safe.

Bullet Head - Single CCT

Delivering advanced, upgraded technology for enhanced home security and surveillance. This model features a refined 1296P (3MP) camera for sharper clarity, dual-band Wi-Fi connectivity (2.4GHz and 5GHz) for more reliable performance, and a focused 135° field of vision for precise monitoring. Powerful, motion activated 3000K flood lights illuminate instantly when activity is detected, and the modern, bullet-shaped adjustable heads allow you to direct light exactly where it's needed. View live footage and event history remotely from any mobile device through the STARFISH APP—anywhere, any time.



65-901R1



65-900R1



65-902R1

- Local Storage**
Up to 128GB Micro SD Local Storage (32GB Included)
- Adjustable 1296p HD Video Camera with 135° Viewing Angle**
- Microphone & Speaker**
For Two-Way Talk
- Dimmable with STARFISH APP**
- Adjustable Flood Lights**
For Optimal Performance
- Mounts to Surface and Recessed Junction Boxes**
- IR Night Vision**
- LED Indicator Light**
- 270° Infrared PIR Sensor**

**— NO —
MONTHLY
SUBSCRIPTION**
32 GB MICRO SD CARD INCLUDED

Download Spec Sheet



ITEM SPECIFICATIONS / ORDER INFO

WIFI 2.4GHz No Hub Required
WIFI 5GHz No Hub Required
DIMMABLE WITH APP
WET LOCATION
3 YEAR WARRANTY
IP 65
2KV SURGE PROTECTION
50,000 HOURS

Item	Finish Color	Wattage	Replacement Wattage	Lumens	Volts	CCT	Viewing Angle
65-900R1	White	20W	100W	1900	120-277V	3000K	135°
65-901R1	Black	20W	100W	1900	120-277V	3000K	135°
65-902R1	Bronze	20W	100W	1900	120-277V	3000K	135°

SMART SECURITY LIGHT & CAMERA

Rectangular Head - CCT Tunable via STARFISH APP

The latest technology in home security and surveillance. Tunable white flood lights via the STARFISH APP provide illumination when it's needed most. View live and event history remotely from any mobile device with the STARFISH APP anywhere, any time.

Adjustable Flood Lights and Camera
For Optimal Performance

Control
Dimming and Color Tuning Controlled through STARFISH APP

Local Storage
Up to 128GB Micro SD Local Storage (32GB Included)

Easy Install
Mounts to Surface or Recessed Junction Box

IR Night Vision
Enhanced Visibility in Low-Light and Complete Darkness

LED Indicator Light

1080p HD Video Camera with 100° Wide Angle View

Advanced Motion Detection
Infrared PIR Sensor

2-Way Talk with Microphone & Speaker

65-921



65-920

**— NO —
MONTHLY
SUBSCRIPTION**
32 GB MICRO SD CARD INCLUDED

WIFI 
2.4GHz
No Hub Required

2-way talk

remote access

night vision

AWS secure encryption

dimming with APP

Download Spec Sheet



DIMMABLE WITH APP

WET LOCATION

3 YEAR WARRANTY

IP 65

50,000 HOURS

Tunable White

ITEM SPECIFICATIONS / ORDER INFO

Item	Finish Color	Wattage	Replacement Wattage	Max Lumens	Volts	CCT (Via APP)	Viewing Angle
65-920	White	36W	200W	4500	120-277V	3000K-5000K	100°
65-921	Black	36W	200W	4500	120-277V	3000K-5000K	100°

Bullet Head - 3 CCT Selectable

The latest technology in home security and surveillance. CCT selectable flood lights provide illumination when it's needed most. View live and event history remotely from any mobile device with the STARFISH APP—anywhere, any time. These energy efficient Smart fixtures are also compatible with Google Home, Alexa, and Siri so they can be easily incorporated into your Smart home.

Adjustable Flood Lights and Camera
For Optimal Performance

CCT Selectable

Control
Dimming through STARFISH APP

Local Storage
Up to 128GB Micro SD Local Storage (32GB Included)

Easy Install
Mounts to Surface or Recessed Junction Box

IR Night Vision
Enhanced Visibility in Low-Light and Complete Darkness

LED Indicator Light

1080p HD Video Camera with 100° Wide Angle View

Advanced Motion Detection
Infrared PIR Sensor

2-Way Talk with Microphone & Speaker



65-931

65-930

**— NO —
MONTHLY
SUBSCRIPTION**
32 GB MICRO SD CARD INCLUDED

WIFI 
2.4GHz
No Hub Required

2-way talk

remote access

night vision

AWS secure encryption

dimming with APP

Download Spec Sheet



DIMMABLE WITH APP

WET LOCATION

3 YEAR WARRANTY

IP 65

50,000 HOURS

ITEM SPECIFICATIONS / ORDER INFO

Item	Finish Color	Wattage	Replacement Wattage	Max Lumens	Volts	CCT Select	Viewing Angle
65-930	White	20W	100W	1750	120-277V	3000K/4000K/5000K	100°
65-931	Black	20W	100W	1750	120-277V	3000K/4000K/5000K	100°

SMART VIDEO DOORBELLS

Our video doorbells provide the latest technology in home security without the monthly subscription fees. Video is stored directly to the local microSD card, eliminating the concern of cloud data breaches and camera hacking. Instantly view all recorded events seamlessly on your mobile device anywhere, any time!

FEATURES

- No Subscription Necessary - Simple Plug & Play Installation
- Remote Viewing, Two-Way Talk
- Wireless or Wired Installation Available
- Wired Installation Replaces Existing Low Voltage Doorbells
- HD Video Camera with Wide Viewing Angle
- Real-time Motion Alerts and Remote Viewing
- Live and Event History Monitoring
- Human Body Detection and Sound Detection
- Local Storage, 32GB SD Card Included - Expandable to 128GB
- Wireless Control Using the STARFISH APP

WIFI

2.4GHz

No Hub Required



2-way
talk



remote
access



night
vision



AWS secure
encryption



STARFISH Quick Tip

Watch a video about
using Data Dashboard
with the STARFISH APP



— NO —
MONTHLY
SUBSCRIPTION
32 GB MICRO SD CARD INCLUDED

Chime plugs into standard 120V outlet



65-933 & 65-934

65-935 & 65-936

Download Spec Sheet



Wired or Wireless Video Doorbell with Chime



OPTIONAL BATTERY OPERATION



WET LOCATION



IP 65

Item	Finish Color	Camera Resolution	Field of View
65-933	White	2048P (3MP)	170° Diagonal
65-934	Black	2048P (3MP)	170° Diagonal

ADDITIONAL ACCESSORIES (SOLD SEPARATELY)

Item	Description
86-933	Chime for White Finish
86-934	Chime for Black Finish



Download Spec Sheet



Wireless Video Doorbell with Chime



BATTERY OPERATION



WET LOCATION



IP 65

Item	Finish Color	Camera Resolution	Field of View
65-935	White	1080P (2MP)	140° Diagonal
65-936	Black	1080P (2MP)	140° Diagonal

ADDITIONAL ACCESSORIES (SOLD SEPARATELY)

Item	Description
86-935	Chime for White Finish
86-936	Chime for Black Finish



SMART INDOOR AND OUTDOOR CAMERAS

Easily expand your home security with SATCO's Indoor and Outdoor Cameras. View in real-time or review motion-activated events on your mobile device from anywhere. Engage in conversation with the two-way talk feature. Each camera has an included 32GB SD Card - No Subscription, ever.

FEATURES

- No Subscription Necessary - Simple Plug & Play Installation
- Remote Viewing, Two-Way Talk
- HD Video Camera with Wide Viewing Angle
- Real-time Motion Alerts and Remote Viewing
- Live and Event History Monitoring
- Human Body Detection and Sound Detection
- Local Storage, 32GB SD Card Included - Expandable to 128GB
- Wireless Control Using the STARFISH APP
- IP65 Rated (Outdoor Cameras)

WIFI
2.4GHz
No Hub Required



2-way talk



remote access



night vision



AWS secure encryption



STARFISH Quick Tip

Watch a video about using Multiview with the STARFISH APP



**— NO —
MONTHLY
SUBSCRIPTION**

32 GB MICRO SD CARD INCLUDED



65-926

65-940

65-925

65-945R1

Download Spec Sheet



Outdoor Pan & Tilt Camera with Solar Panel



OPTIONAL BATTERY OPERATION



WET LOCATION

Item	Finish Color	Camera Resolution	Rotation Angle	Field of View	LED Lights
65-926	White/Black	1620P (5MP)	Pan 355°, Tilt 70°	135° Diagonal	360 Lumens, 6000K

Download Spec Sheet



Outdoor Pan & Tilt Camera - Plug-In



WET LOCATION

Item	Finish Color	Camera Resolution	Rotation Angle	Field of View	LED Lights
65-925	White	1296P (3MP)	Pan 310°, Tilt 130°	110° Diagonal	400 Lumens, 6000K

Download Spec Sheet



Indoor Security Camera - Plug-In

Item	Finish Color	Camera Resolution	Field of View	LED Lights
65-940	White	1080P (2MP)	93° Diagonal	N/A

Download Spec Sheet



Indoor Pan & Tilt Camera - Plug-In

Item	Finish Color	Camera Resolution	Rotation Angle	Field of View	LED Lights
65-945R1	White	1296P (3MP)	Pan 355°, Tilt -10° - 40°	102° Diagonal	N/A

SMART COLOR CHANGING UNDER CABINET FIXTURES

Our easy to install COUNTERQUICK® fixtures are a high quality under cabinet lighting solution with Smart Wi-Fi technology. The STARFISH APP offers remote access with dimming capabilities, timers to set routines, voice control, changes to colors and temperatures in order to add style and ambiance to any occasion. Use the tunable white option to adjust illumination from warm and cozy to cool and task driven.

FEATURES

- RGB Color-Changing and Tunable White 2700K-5000K
- Mix Different Lengths to Configure Custom Installations
- Easy Keyhole Mounting
- Direct Wire or Plug-In Installation Options
- Dimmable with STARFISH APP
- Pre-set and Custom Color-Changing Effects
- Commercial, Residential, Multi-Family



WIFI
2.4GHz
No Hub Required

STARFISH® Quick Tip

Watch a video about adjusting colors, CCTs and brightness using the STARFISH APP



WIRING MADE EASY

Ample internal wiring space for ease of installation. Optional under cabinet junction boxes offer even greater flexibility for retrofit applications or installations in tight areas. Use the cord and plug accessory when direct wiring isn't an option or if you want a simple update without a complete remodel.



KEEPING IT CLEAN

One power source is all that's needed for most applications, making for a clean installation. Optional extension cables in various lengths interconnect fixtures across large areas, around corners and between cabinets, eliminating the need for additional wiring to the power source or outlet.



GOING TO NEW LENGTHS

The included end-to-end wire connector allows you to mix and match various sizes and to configure customized lengths for any under cabinet installation.

COUNTERQUICK®

LED Linkable Under Cabinet Fixture



Download
Spec Sheet



90
CRI

DIMMABLE
WITH APP

3YEAR
WARRANTY

25,000
HOURS

Tunable
White

RGB
Color

ITEM SPECIFICATIONS / ORDER INFO

Item	Size	Wattage	Max Lumens	Volts	CCT	Dimensions	Connection QTY
63-551	11"	6.5W	474	120V	2700K-5000K	11" x 3.5" x 1"	Up to 72
63-552	14"	9W	538	120V	2700K-5000K	14" x 3.5" x 1"	Up to 48
63-553	22"	13W	878	120V	2700K-5000K	22" x 3.5" x 1"	Up to 36
63-554	28"	17W	1209	120V	2700K-5000K	28" x 3.5" x 1"	Up to 22
63-555	34"	20W	1420	120V	2700K-5000K	34" x 3.5" x 1"	Up to 18

OPTIONAL ACCESSORIES (SOLD SEPARATELY)

Item	Description
63-510	5 Ft. Power Cord
63-511	End-to-End Connector (1 included with fixture) For regular COUNTERQUICK Fixtures only
63-513	White Plastic Junction Box with 3/8" Wire Connector (63-512)
63-514	Metal Junction Box
63-515	6" Link Cable
63-516	12" Link Cable
63-517	24" Link Cable
63-518	Male-to-Female Cable Link Connector



63-510



63-511



63-513



63-514



63-515 (6")
63-516 (12")
63-517 (24")



63-518

DIMENSION SMART COLOR CHANGING TAPE LIGHT KITS

Unlock a world of possibilities with DIMENSION Tape Light - the versatile tape light designed for residential lighting and more. Choose from millions of vibrant colors or create the perfect ambiance. Sync the lighting to your favorite soundtrack and elevate your gaming experience or transform your living space. With its user-friendly features and top-notch quality, DIMENSION™ brings a touch of magic to any setting.

FEATURES

- Dynamic RGB Color-Changing and Tunable White 2700K to 6500K
- High Brightness with DIMENSION Pro
- Standard Brightness with DIMENSION Plus
- 16 Ft., 32 Ft. & 64 Ft. Kits Available
- IR/RF Remote or STARFISH APP Controlled
- Available in Plug-In or Direct Wire Junction Box Kits
- Cutable and Linkable (Indoor Only)
- Dimmable with STARFISH APP or Remote
- Pre-set and Custom Color-Changing Effects
- Commercial and Residential

STARFISH Quick Tip

Watch a video about locating product manuals with the STARFISH APP



WIFI

2.4GHz



No Hub Required



DIMENSION®

Indoor & Outdoor LED Tape Light Kits



Download Spec Sheet



DIMENSION Plus - Indoor - Standard Brightness

Each Kit includes: Reel of LED Tape Light, Plug-In Driver or Direct Wire Junction Box, Controller/Receiver and IR Remote Control



Item	Length	Style	Wattage	Lumens	Number of Reels	Volts	DC Voltage	CCT
64-120	16'	Plug-In	12W	1120	1	120V	24V	2700-6500K
64-121	16'	Direct Wired	14W	1120	1	120V-277V	24V	2700-6500K

Download Spec Sheet



DIMENSION Pro - Indoor - High Brightness

Each Kit includes: Reel of LED Tape Light, Plug-In Driver or Direct Wire Junction Box, Controller/Receiver and IR Remote Control



Item	Length	Style	Wattage	Lumens	Number of Reels	Volts	DC Voltage	CCT
64-130	16'	Plug-in	18W	1920	1	120V	24V	2700-6500K
64-131	32'	Plug-in	30W	3080	1	120V	24V	2700-6500K
64-132	64'	Plug-in	68W	6300	2	120V	24V	2700-6500K
64-133	16'	Direct Wired	20W	1920	1	120-277V	24V	2700-6500K
64-134	32'	Direct Wired	30W	3080	1	120-277V	24V	2700-6500K
64-135	64'	Direct Wired	68W	6300	2	120-277V	24V	2700-6500K

Download Spec Sheet



DIMENSION Pro - Outdoor - High Brightness

Each Kit includes: Reel of LED Tape Light, Plug-In Driver or Direct Wire Junction Box, Controller/Receiver, RF Remote Control & Mounting Clips



Item	Length	Style	Wattage	Lumens	Number of Reels	Volts	DC Voltage	CCT
64-140	16'	Plug-in	18W	1920	1	120V	24V	2700-6500K
64-141	32'	Plug-in	30W	3080	1	120V	24V	2700-6500K
64-142	64'	Plug-in	68W	6300	2	120V	24V	2700-6500K
64-143	16'	Direct Wired	20W	1920	1	120-277V	24V	2700-6500K
64-144	32'	Direct Wired	30W	3080	1	120-277V	24V	2700-6500K
64-145	64'	Direct Wired	68W	6300	2	120-277V	24V	2700-6500K

DIMENSION™ SMART COLOR CHANGING TAPE LIGHT KITS - ACCESSORIES

Four different tape channels (sold in five sections equaling 16 feet) help secure and protect the tape lights while providing a neat and organized appearance. Connectors and wire cables make it easy to link multiple tape strips together while ensuring a secure and reliable connection.

Kit for Cut Tape

Use leftover indoor tape from a previous installation. The kit comes with everything you need for up to a 16 Ft. tape installation. Plug-in or Junction Box power supply, controller, wire + tape-to-tape connector, and IR or RF Remote Control.

Item	Description
64-172	Tape Control Connector, Plug-In Adapter
64-173	Tape Control Connector, Junction Box



Channels and Diffusers

Item	Type	Description
64-150	Recessed	16' Total Deep Well, 3.28' Length per channel (5 channels in a box)
64-151	Surface	16' Total Deep Well, 3.28' Length per channel (5 channels in a box)
64-154	Surface	16' Total Shallow Well, 3.28' Length per channel (5 channels in a box)
64-152	Corner	16' Total 45° Corner Angled, 3.28' Length per channel (5 channels in a box)

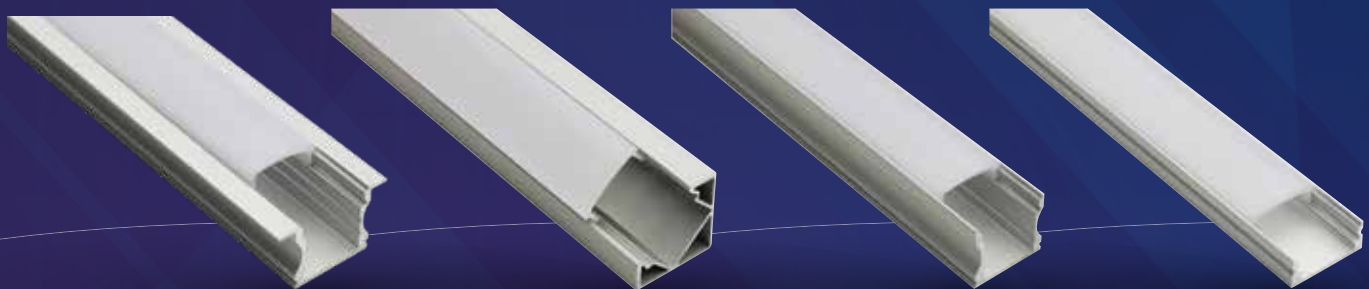

64-150

64-152

64-151

64-154



Tape-to-Tape Wire & Connectors

Item	Description
64-160	Tape-to-Tape Connector
64-161	6" Jumper Wire
64-162	90° Connector
64-174	3-Way Tape-to-Tape Connector
64-175	4-Way Tape-to-Tape Connector

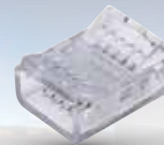

64-160

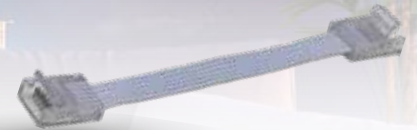

64-161



64-162



64-174



64-175

Wire-to-Tape Wire & Connectors

Item	Description
64-164	Wire-to-Tape Connector
64-165	50' Tape Wire



64-164



64-165

Indoor Tape Extension Cords

Item	Description
64-170	16' Power Indoor Extension Cord
64-176	10' Indoor Extension Cord with M2M Pins



64-176



64-170

Outdoor Tape Accessories

Item	Description
64-163	Mounting Clips, 20 Pack
64-166	Plastic End Caps & Glue Set
64-171	10' Power Outdoor Extension Cord



64-163



64-171



64-166

SMART COLOR CHANGING STRING LIGHTS

Delivering virtually unlimited color selections and control with the STARFISH APP. Easily install with the integrated hanging hooks, connect to the APP, and tailor the ambiance of your patio, dining area, or party space. Choose from millions of vibrant RGB colors, color combinations, or a wide range of warm to natural light white. Pre-set and custom color changing effects allow for another level of personalization to make your event extra special. Choose color bulb-by-bulb or all the same. Additional sets can be connected to make one continuous strand to illuminate larger spaces.

FEATURES

- 24 Ft. & 48 Ft. Models Available
- Connect Multiple Strands Together
- RGB & 3000K-6500K CCT Tunable
- Pre-Set and Custom Color Changing Effects
- Durable Acrylic Bulb, Replacement Bulbs Available
- Heavy Duty 18 Gauge Wire
- Integrated Hanging Hook
- Wet Location, IP65



 **STARFISH Quick Tip**
Select each bulb (DIY) using the STARFISH APP

Adjust brightness and saturations or use preset color temperatures for quick selection

Change all bulbs at the same time, or choose each bulb one by one.

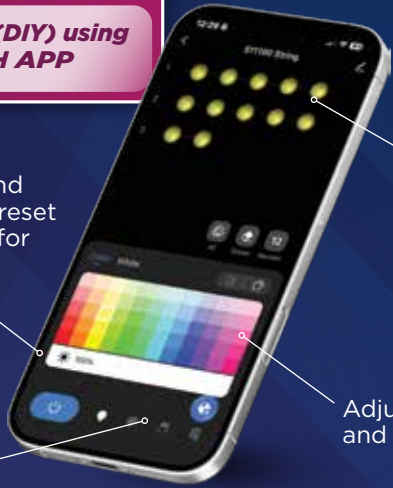

Adjust the color and create a vibe

Music Sync

WIFI 
2.4GHz
No Hub Required



SELECT A COLOR

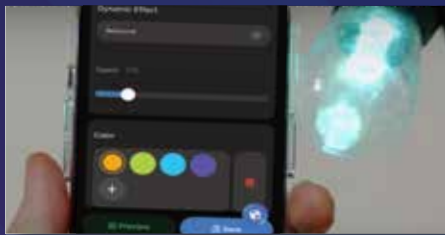

CREATE SPECIAL EFFECTS

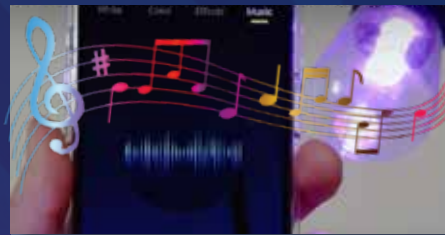

SYNC YOUR MUSIC



Multi-Purpose Controller: Pairing, on/off and pre-configured special effects button Easily pair to your mobile device by holding on/off button for 5-10 seconds.

Toggle button to select your choice of special effects:

- Scenery 1: Flower harbor Scenery 4: Willows
- Scenery 2: Lotus flower Scenery 5: Glacier express
- Scenery 3: Iceland blue Scenery 6: Sea of clouds

STARFISH string lights may also be operated through the control button on the controller



Download Spec Sheet

DIMMABLE WITH APP

WET LOCATION

IP 65

30,000 HOURS

ITEM SPECIFICATIONS / ORDER INFO

Item	Length	Number of Bulbs	Max Connectable Units	Wattage Per Set	CCT Tunable	RGB
S11190	24'	12	5	7W	3000K-6500K	Millions of Colors
S11191	48'	15	4	9W	3000K-6500K	Millions of Colors

OPTIONAL ACCESSORIES (SOLD SEPARATELY)

Item	Description
S8054	0.5W STARFISH Replacement Lamp
80-2882	6' Extension Cord for STARFISH String Lights, Black



80-2882



S8054

SMART COLOR CHANGING EAVE LIGHTS

Transform your home into a glowing destination with STARFISH Smart LED Eave Lights, designed to deliver year-round magic with effortless elegance. Whether you're celebrating the holidays, hosting under the stars, or simply elevating everyday curb appeal, these lights bathe your exterior in millions of vibrant colors and beautifully tunable white tones. Easily installed under eaves and soffits with no hardwiring required, they plug into a standard outlet for instant impact and lasting brilliance. Control every mood and moment through the STARFISH APP or included remote, creating custom effects that match any season or celebration. With Smart home compatibility and weather-ready durability, STARFISH lighting makes your home shine brighter-every night of the year.

FEATURES

- 50 Ft. & 100 Ft. Models Available
- Connect an Additional 25 Ft. Extension for 75 Ft. and 125 Ft. Max Run
- STARFISH Smart Enabled with APP Control, No Hub Required
- RGB & 2200K-6500K CCT Tunable
- Pre-Set and Custom Color Changing Effects
- Adhesive Mounting Pad and Screws Included for Installation
- Wet Location, IP65

INCLUDED ACCESSORIES



Plug-In Driver



Controller/Receiver



IR Remote



Mounting Screws



Adhesive Mounting Pads



(2) 25 Ft. 18 Light Sections or
(4) 25 Ft. 18 Light Sections



STARFISH Quick Tip

Enjoy enhanced effects and create your own effects using the STARFISH APP

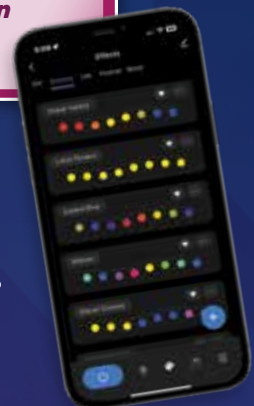

WIFI

2.4GHz

No Hub Required



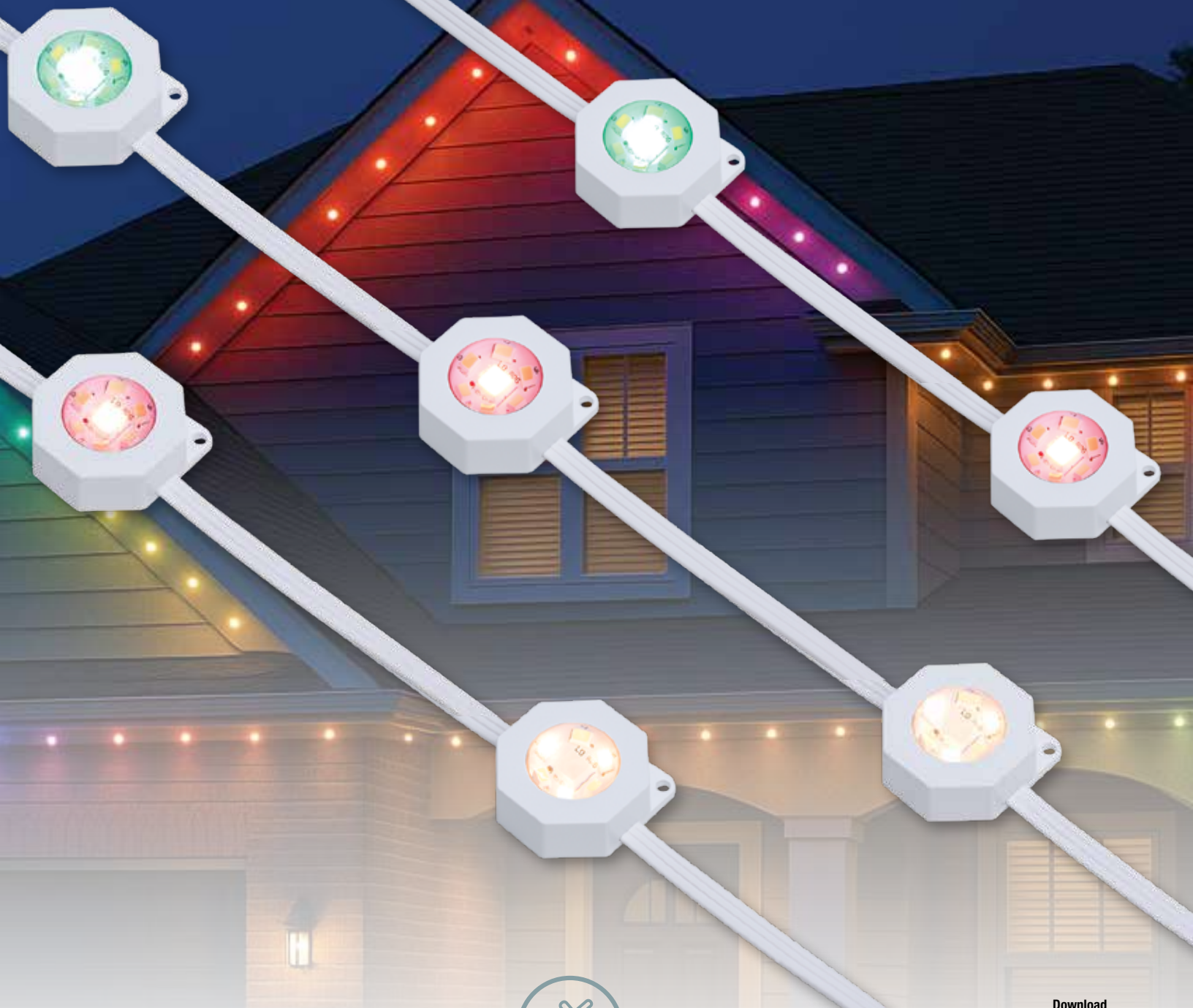

Plug-In

Download
Spec Sheet



ITEM SPECIFICATIONS / ORDER INFO

Item	Length	Number of Lamps	Volts	Wattage	Replacement Wattage	Lumens	CCT
S11297	50 Ft.	36	120V	24W	75W	1200	2200K-6500K
S11298	100 Ft.	72	120V	48W	125W	2400	2200K-6500K

OPTIONAL ACCESSORIES (SOLD SEPARATELY)

Item	Description
S11299	25 Ft. Extension Pack (18 Lamps)
S11299/2LEXT	2.75 Ft. Extension (2 Lamps)
S11299/3LEXT	4.33 Ft. Extension (3 Lamps)
80-2883	10 Ft. Extension Cord



S11299



80-2883

SMART COLOR CHANGING LANDSCAPE FLOOD LIGHTS

A sophisticated choice for Smart outdoor lighting. Download the STARFISH APP to customize any tunable white color temperatures from 2700K warm white light to 5000K natural light or choose from millions of colors on the RGB spectrum, all from your mobile device. Build scenes and set schedules to customize ambiance and create a unique lighting experience. These fixtures are also compatible with Siri, Alexa, Google Home, and SmartThings so they can be easily incorporated into your Smart home.

FEATURES

- STARFISH Smart Enabled
- RGB Color-Changing and Tunable White 2700K - 5000K
- Dimmable via STARFISH APP
- Pre-Set and Custom Color-Changing Effects
- Bronze Finish
- Wet Rated, IP65
- Die-Cast Aluminum
- Mounting Plate Included
- Advanced Pairing Technology

Install within 80 feet of the router/extender for stable performance



STARFISH Quick Tip

Watch a video about creating an Automation using the STARFISH APP



WIFI 
2.4GHz
No Hub Required



62-5901



62-5903



62-5902



Mounting Plate
Included

Download
Spec Sheet



ITEM SPECIFICATIONS / ORDER INFO

Item	Finish Color	Style	Volts	Input Current	Wattage	Replacement Wattage	Lumens	CCT
62-5901	Bronze	PAR16	120V	0.05A	6W	45W	480	2700K-5000K
62-5902	Bronze	PAR20	120V	0.08A	9W	65W	800	2700K-5000K
62-5903	Bronze	PAR30	120V	0.08A	12W	75W	1240	2700K-5000K

SMART COLOR CHANGING OUTDOOR LANTERNS

Embrace the charm of traditional design with the East River & Austen Collections, where every detail tells a story of craftsmanship. With the latest in LED technology, this suite of outdoor fixtures can all be fine-tuned to suit your exterior lighting needs with the STARFISH APP. Featuring tunable warm to cool white from 2700K-5000K, as well as RGB in a range of millions of colors. The clear water glass panels not only add a touch of nostalgia but also allow the multitude of color options to shine through, creating a mesmerizing play of light that beautifully complements your outdoor environment.

FEATURES

- STARFISH Smart Enabled
- RGB Color-Changing and Tunable White 2700K-5000K
- Dimmable via STARFISH APP
- Pre-Set and Custom Color-Changing Effects
- Hanging Lanterns - Damp/Outdoor Location Rated
- Wall Lanterns - Wet/Outdoor Location Rated
- Matte Black Finish
- Die-Cast Aluminum with Clear Water Glass



STARFISH Quick Tip

Watch a video about creating a Scene using the STARFISH APP



WIFI 
2.4GHz
No Hub Required



62-5944



62-5945



62-5996



62-5997

East River Collection

ITEM SPECIFICATIONS / ORDER INFO

Item	Description	Wattage	Lumens	Location Rating	CCT
62-5944	Hanging	10W	850	Damp	2700K-5000K
62-5945	Wall	10W	850	Wet	2700K-5000K



Download Spec Sheet

Austen Collection

ITEM SPECIFICATIONS / ORDER INFO

Item	Description	Wattage	Lumens	Location Rating	CCT
62-5996	Hanging	10W	850	Damp	2700K-5000K
62-5997	Wall	10W	850	Wet	2700K-5000K



Download Spec Sheet

PROGRAMMABLE REMOTE

Once paired with the STARFISH APP, the programmable remote provides convenient control of Smart lighting within a 50-foot range. Users can adjust brightness, modify color temperature, and cycle through colors and dynamic effects across multiple devices. Together with the APP, it delivers a customizable, intuitive, and responsive lighting experience for any space.

FEATURES

- Adjust Brightness Levels
- Change Color Temperature
- Cycle Through a Range of Colors and Dynamic Lighting Effects
- Create Up to 4 Groups
- Works Within a 50-foot Radius for Convenient Remote Operation
- Controls Multiple Lighting Devices at Once
- Devices Must be Paired with STARFISH APP Before They Can be Paired with Programmable Remote

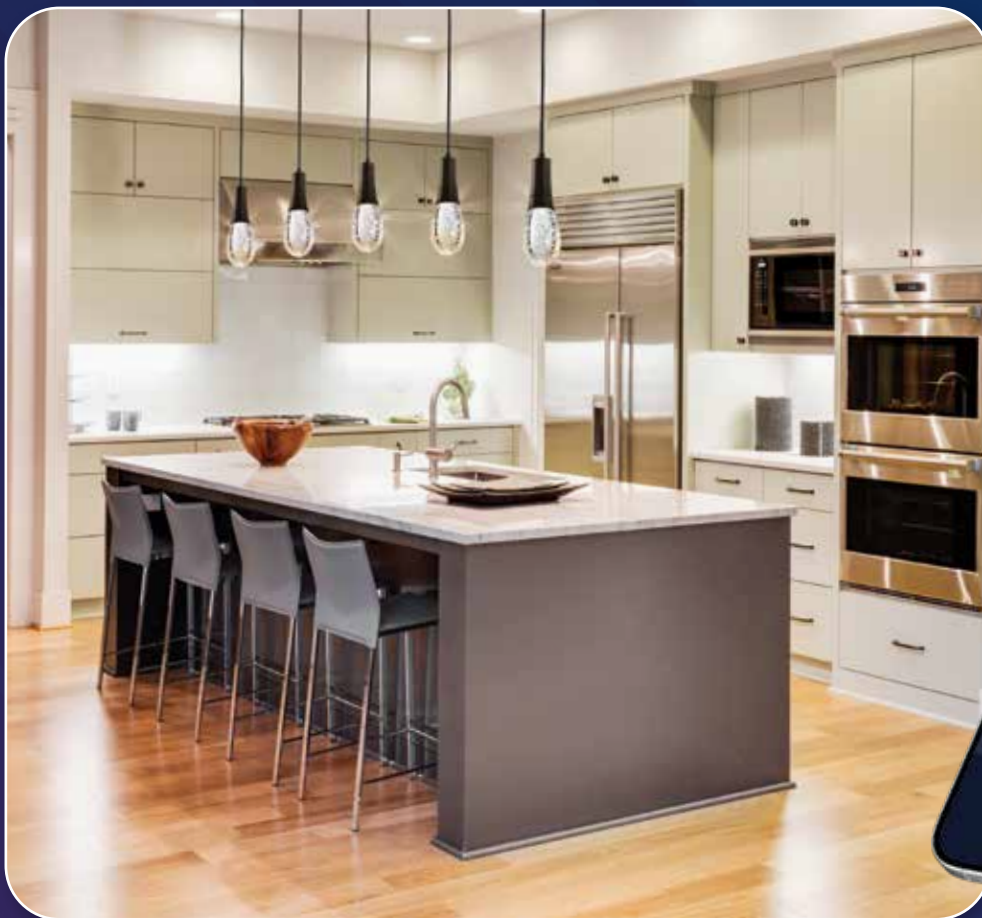

For Compatible STARFISH Products Scan Here:



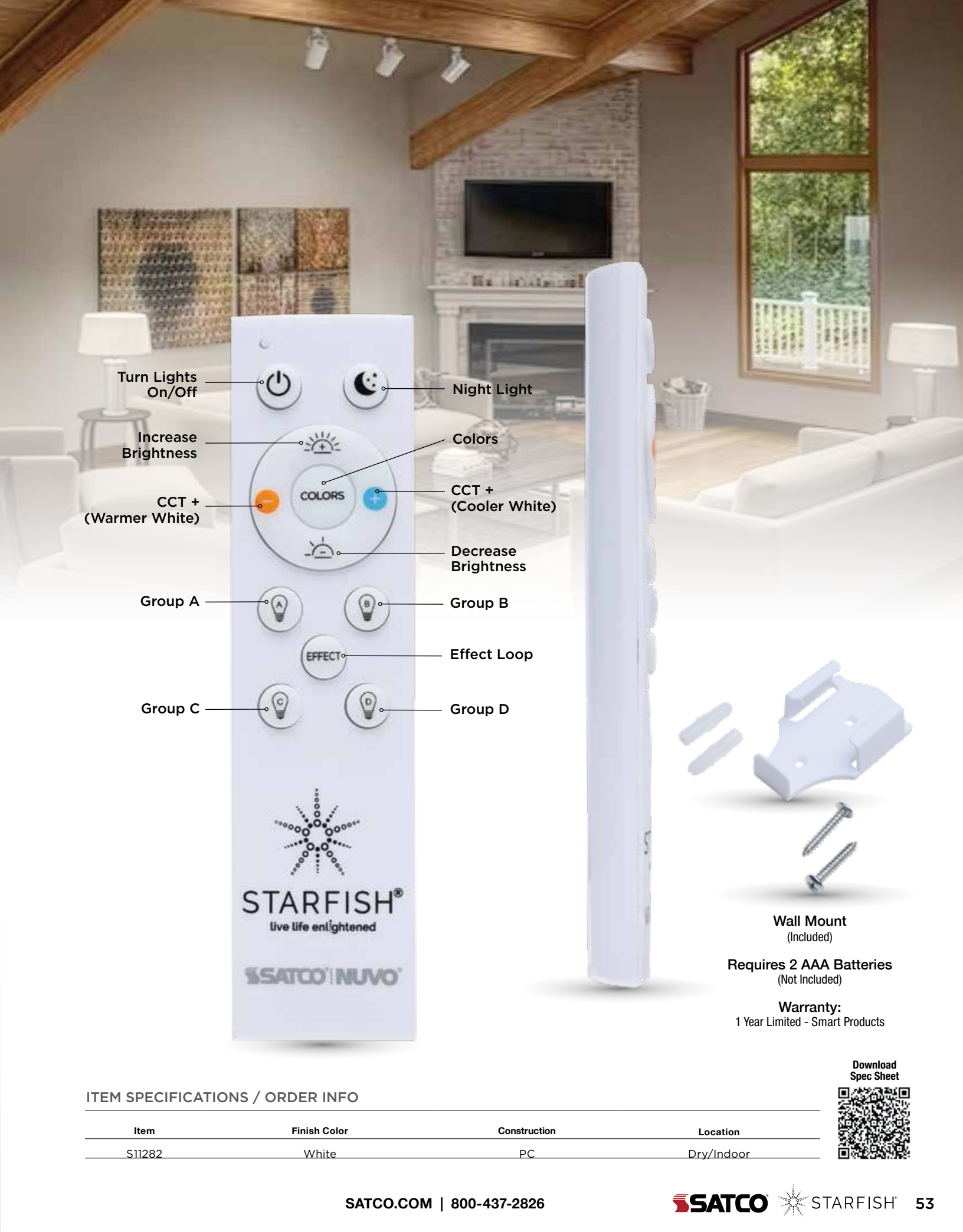

- Turn Lights On/Off
- Night Light
- Increase Brightness
- Colors
- CCT + (Warmer White)
- CCT + (Cooler White)
- Decrease Brightness
- Group A
- Group B
- Effect Loop
- Group C
- Group D

STARFISH®
 live life enlⁱghtened
SATCO | NUVO®

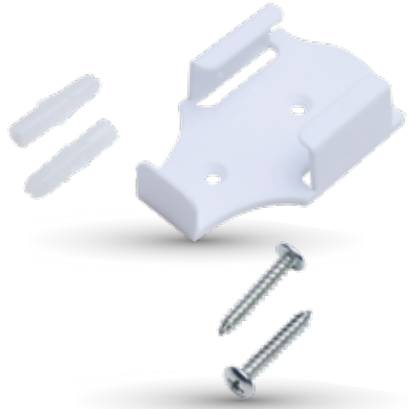

Wall Mount
 (Included)
Requires 2 AAA Batteries
 (Not Included)
Warranty:
 1 Year Limited - Smart Products

ITEM SPECIFICATIONS / ORDER INFO

Item	Finish Color	Construction	Location
S11282	White	PC	Dry/Indoor



SMART PLUGS, SWITCHES & RECEPTACLE

Smart Plugs, Switches, and Receptacles offer a simple way to modernize your space with clean design and reliable performance. Designed to integrate seamlessly into your electrical setup, they provide convenient control of connected devices and lighting while maintaining a polished, streamlined look. A smart solution for enhancing functionality without compromising style.

FEATURES

- Set-up Schedules and Timers*
- Plugs and Strips Make Any Product Smart
- Seamless Integration Into Standard Electrical Setups
- Enhances Control of Connected Devices and Lighting
- Clean, Built-in Appearance (No Bulky Add-ons)
- Designed for Everyday Reliability
- Ideal for Residential or Light Commercial Spaces
- Elevates Both Functionality and Overall Aesthetic

*Voice Control with Compatible Assistants



 **STARFISH Quick Tip**
Create Schedules using the STARFISH APP to have the devices turn on or off at set times.

WIFI 
2.4GHz
No Hub Required



Download Spec Sheet



S11572



S11573



S11574



S11577



S11578



S11579

ITEM SPECIFICATIONS / ORDER INFO



Item	Description	Finish Color	Amps	Max Watts	Volts	NEMA Type	Location Rating	Construction
S11281	Smart 15A Outdoor Dual Outlet Plug	Matte Black	15A	1,875W	125V	3R	Wet	Polypropylene
S11572	Smart 15A On/Off Indoor Plug	White	15A	1,875W	125V	-	Dry	Polycarbonate
S11573	Smart Indoor Dimmer Plug	White	2.5A	150W (LED)	125V	-	Dry	Polycarbonate
S11574	Smart 4-Outlet Indoor Power Strip	White	15A	1,875W	125V	-	Dry	Polycarbonate
S11577	Smart In-Wall On/Off Switch	White	6A	720W	120V	-	Dry	Polycarbonate
S11578	Smart In-Wall Dimmer	White	6A	150W (LED)	120V	-	Dry	Polycarbonate
S11579	Smart In-Wall Dual Receptacle	White	15A	1,800W	120V	-	Dry	Polycarbonate

STARFISH SMART USES

Creative Uses For STARFISH

STARFISH LED Smart products are a convenient way to connect and create a vibe! STARFISH LED brings a stylish, affordable, lighting solution to illuminate your space. The capabilities of SATCO's Smart bulbs when used with the STARFISH APP will create an entirely immersive experience.

Add some atmosphere with dynamic RGB lights! Self-adhering tape lights are flexible and fun, use the Smart dimming and tunable white features for a soft elegant glow or to wash the room in colors for a techni-color vibe! STARFISH tape lights fit great along the edge of your TV. Sync the lights with the sounds of your TV to give your room an entire theater vibe.



PLAN A ROMANTIC EVENING UNDER THE STARS!

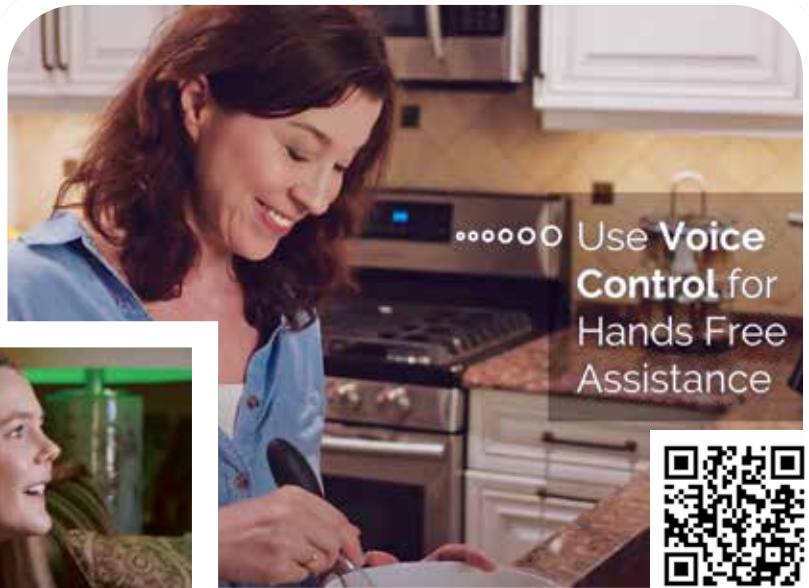

Use Voice Control for Hands Free Assistance



DYNAMIC COLOR CHANGING EFFECTS FOR GAMING!





STARFISH smart bulbs have also been used in wedding venues for colorful dance floor lighting, DJ booth lighting, and up-lighting! There are so many interesting ways to arrange STARFISH Smart lights.



INDEX

62-5901.....	49	64-165.....	43	S11242.....	19
62-5902.....	49	64-166.....	43	S11243.....	19
62-5903.....	49	64-170.....	43	S11244.....	17
62-5944.....	51	64-171.....	43	S11245.....	17
62-5945.....	51	64-172.....	42	S11246.....	17
62-5996.....	51	64-173.....	42	S11281.....	55
62-5997.....	51	64-174.....	43	S11282.....	53
62-6001.....	29	64-175.....	43	S11293R1.....	23
62-6002.....	29	64-176.....	43	S11294R1.....	23
62-6003.....	29	65-900R1.....	31	S11295R1.....	23
63-510.....	39	65-901R1.....	31	S11296R1.....	23
63-511.....	39	65-902R1.....	31	S11297.....	47
63-512.....	39	65-920.....	32	S11298.....	47
63-513.....	39	65-921.....	32	S11299.....	47
63-514.....	39	65-925.....	37	S11299/2LEXT.....	47
63-515.....	39	65-926.....	37	S11299/3LEXT.....	47
63-516.....	39	65-930.....	33	S11560.....	21
63-517.....	39	65-931.....	33	S11561.....	22
63-518.....	39	65-933.....	35	S11562.....	21
63-551.....	39	65-934.....	35	S11563.....	22
63-552.....	39	65-935.....	35	S11564.....	21
63-553.....	39	65-936.....	35	S11565.....	22
63-554.....	39	65-940.....	37	S11566.....	21
63-555.....	39	65-945R1.....	37	S11567.....	22
64-120.....	41	80-2882.....	45	S11568.....	25
64-121.....	41	80-2883.....	47	S11569.....	25
64-130.....	41	86-933.....	35	S11570.....	25
64-131.....	41	86-934.....	35	S11571.....	25
64-132.....	41	86-935.....	35	S11572.....	55
64-133.....	41	86-936.....	35	S11573.....	55
64-134.....	41	S11100.....	11	S11574.....	55
64-135.....	41	S11101.....	11	S11575.....	9
64-140.....	41	S11102.....	12	S11576.....	9
64-141.....	41	S11103.....	14	S11577.....	55
64-142.....	41	S11104.....	14	S11578.....	55
64-143.....	41	S11105.....	14	S11579.....	55
64-144.....	41	S11106.....	15	S11636.....	21
64-145.....	41	S11107.....	15	S11637.....	21
64-150.....	42	S11108.....	15	S11638.....	25
64-151.....	42	S11109.....	13	S11639.....	25
64-152.....	42	S11110.....	13	S8054.....	45
64-154.....	42	S11111.....	12	TH903.....	27
64-160.....	43	S11112.....	12	TH904.....	27
64-161.....	43	S11190.....	45	TH913.....	27
64-162.....	43	S11191.....	45	TH914.....	27
64-163.....	43	S11240.....	17	TP176.....	27
64-164.....	43	S11241.....	18	TP177.....	27





STARFISH®



To learn more about SATCO, visit www.satcostarfish.com or contact 1-800-437-2826



Like us on Facebook



Connect with us on LinkedIn



Follow us on Instagram

National Toll-Free: 1.800.43.SATCO (1.800.437.2826)

**Corporate Offices &
Distribution Center:**

NEW YORK 110 Heartland Blvd., Brentwood, NY 11717 | 800.437.2826 | 631.243.2022 | Fax 631.243.2027

Distribution Centers:

FLORIDA 1694 NW 215th St. Miami Gardens, FL 33056 | Tel. 305.624.2044 FAX 305.623.0286

CALIFORNIA 31288 San Benito St. Hayward, CA 94544 | Tel. 510.487.4822 FAX 510.487.8955

WASHINGTON 4710 116th St. S.W., Mukilteo, WA 98275 | Tel. 425.789.3300 FAX 425.789.3310

TEXAS 2000 Valwood Parkway, Farmers Branch, TX 75234 | Tel. 972.247.2437 FAX 972.247.5408

PUERTO RICO Campeche St. 23, Julio N. Matos Industrial Park, Carolina, PR 00984 | Tel. 787.757.3510 FAX 787.757.3540

Product specifications and availability are subject to change without notice.

Please visit us online at www.satco.com for our full product line and ordering details, or consult factory for additional information.