

# ROUND COMMERCIAL DOWNLIGHTS

PERFORMER SERIES | FIELD SELECTABLE  
REMOTE DRIVER



Available in 4", 6", 8" Sizes

The SATCO|NUVO Performer Series LED Recessed Downlights are engineered to deliver dependable, high-quality illumination for commercial environments. Offered in 4, 6, and 8-inch round sizes, these downlights feature wattage and CCT selectable technology and provide 90 CRI light for accurate color rendering. All models are IC rated, airtight, and suitable for wet locations, and are ENERGY STAR® and Title 24 compliant. FT6 cabling supports commercial installations, while a remote driver allows for flexibility in shallow plenum applications. Field-installable trim accessories add design versatility, and with a 50,000-hour rated life backed by a 5-year warranty, these downlights are well suited for offices, hospitality spaces, retail settings, and other indoor and outdoor commercial applications.

- 

---

- FIELD-INSTALLABLE TRIM  
ACCESSORIES AVAILABLE**

---

- FT6 CABLE FOR COMMERCIAL  
USE**

---

- REMOTE DRIVER FOR  
SHALLOW PLENUMS**

---

- WATTAGE & CCT SELECTABLE**

---

- 90 CRI HIGH QUALITY LIGHT**

---

- SUGGESTED APPLICATIONS**  
Indoor/Outdoor, Offices  
Hospitality, Retail  
Commercial, Residential



**GENERAL SPECIFICATIONS**

**Range Voltage:** 120V-347V  
**Frequency:** 50/60Hz  
**Power Factor:** >0.9  
**THD:** <30%  
**Dimming:** 0-10V Dimmable Down to 10%  
**CRI:** 90+  
**CCT Selectable:** 2700K/3000K/3500K/4000K/5000K  
**Beam Angle:** 90°  
**Location Rating:** Wet  
**Ambient Operating Temperature:**  
 -25°C (-13°F) to +40°C (+104°F)

**IC Rated:** Yes  
**IP Rating:** 54  
**Air Tight Rated:** Yes  
**Finish:** Matte White  
**Construction:** Aluminum  
**Lens Material:** Polycarbonate  
**Functional Life:** 50,000 Hours  
**Warranty:** 5 Years

**ITEM SPECIFICATIONS / ORDER INFO**



Item	Size	Lumens	Wattage Selectable	Max. Replacement Wattage	Efficacy
S13510	4"	1100/900/650	12W/9W/6W	75W	up to 91 LPW
S13511	6"	2000/1500/1100	24W/16W/12W	100W	up to 83 LPW
S13512	8"	2500/2000/1500	30W/22W/16W	125W	up to 83 LPW

**FEATURES**



Aluminum Trim & PC Lens

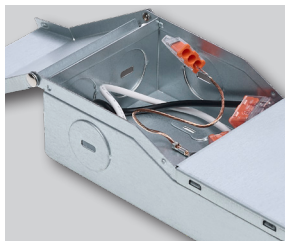

Remote Driver for Shallow Plenums



FT6 Cable for Commercial Use



Spring Clips for Easy Installation



CCT & Wattage Selectable Switches

This device complies with Part 15 of the FCC Rules. Operation is subject to the following two conditions: (1) this device may not cause harmful interference, and (2) this device must accept any interference received, including interference that may cause undesired operation.

WARNING: Some products included in this specification sheet may be subject to the warning requirements of California's Proposition 65. Please refer to your product packaging for more information.

Meets requirements of ICES-005 issue 5. 120V: class B for use in residential applications. 277V & 347V: class A for commercial, industrial or business applications.

Fixture may not be compatible with all dimmers. See satco.com for details.

Replacement wattage shown depends on application and fixture.

Specifications are subject to change without prior notice.

Visit satco.com/service/warranty for complete warranty details.

**DIMENSIONS / WEIGHTS**

Item	Diameter (A)	Height (B)	Weight
S13510	5.04"	2.35"	0.79 Lbs.
S13511	7.36"	2.84"	0.95 Lbs.
S13512	8.66"	3.40"	1.10 Lbs.

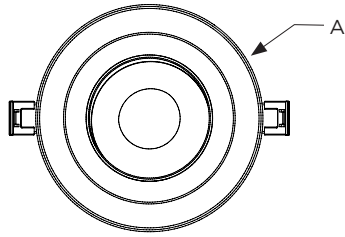

S13510

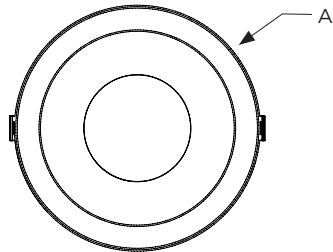
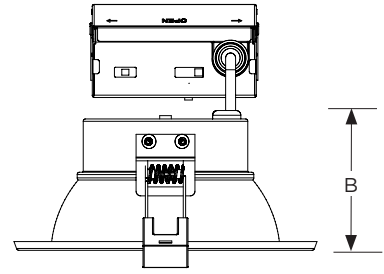

S13511

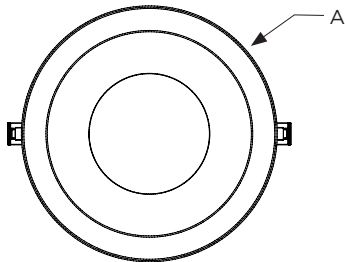
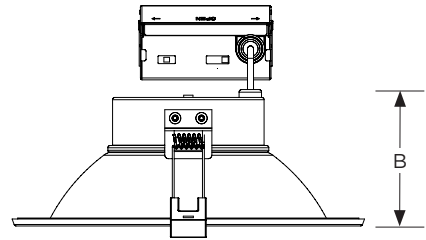

S13512

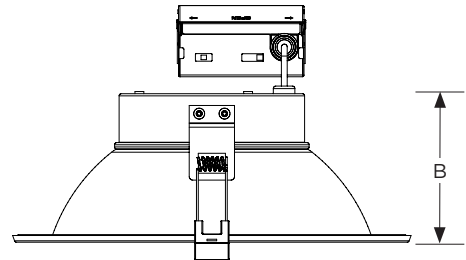

**REMOTE DRIVER AND FT6 CABLE DIMENSIONS**

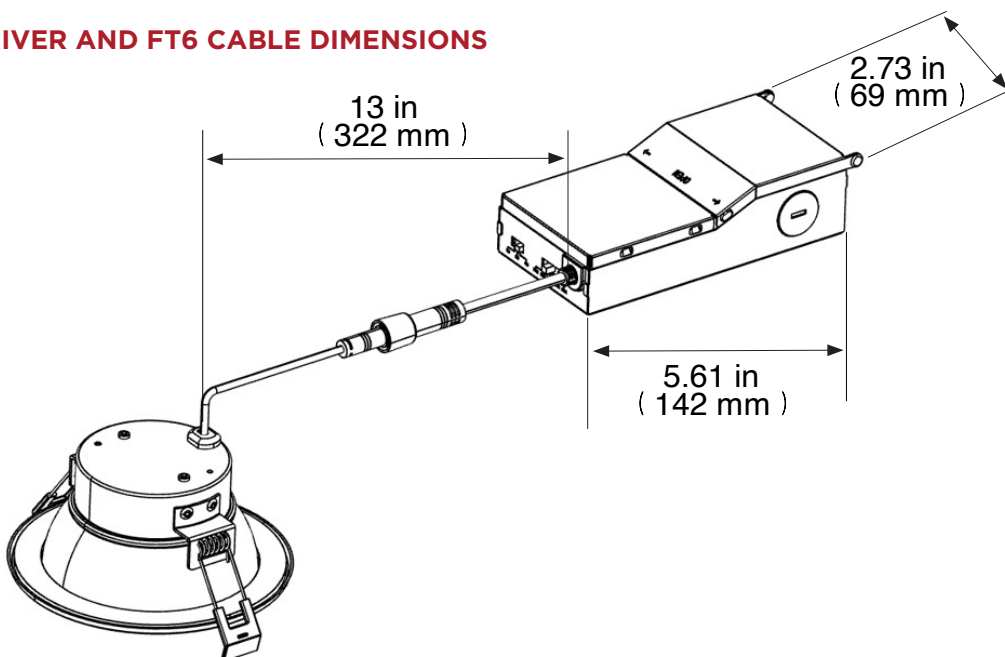

**OPTIONAL ACCESSORIES**

Item	Description
COMPATIBLE WITH S13510	
80-865	4" Asymmetric Mounting Plate For New Construction
80-997	Hanger Bar Kit; For Asymmetrical Plates; New Construction
80-943	4" Mounting Plate With Hanger Bars For New Construction
80-950	4" Mounting Plate For Stud/Joist Mounting For New Construction
S13520	4" Round Commercial DL Trim; Clear/White Finish
S13521	4" Round Commercial DL Trim; Clear Finish
S13522	4" Round Commercial DL Trim; Black Finish
S13540	4" Round Goof Ring for Commercial Downlights; White Finish
COMPATIBLE WITH S13511	
80-866	6" Asymmetric Mounting Plate For New Construction
80-997	Hanger Bar Kit; For Asymmetrical Plates; New Construction
80-944	6" Mounting Plate With Hanger Bars For New Construction
80-952	6" Mounting Plate For Stud/Joist Mounting For New Construction
S13525	6" Round Commercial DL Trim; Clear/White Finish
S13526	6" Round Commercial DL Trim; Clear Finish
S13527	6" Round Commercial DL Trim; Black Finish
S13541	6" Round Goof Ring for Commercial Downlights; White Finish
COMPATIBLE WITH S13512	
80-945	8" Mounting Plate With Hanger Bars For New Construction
80-953	8" Mounting Plate For Stud/Joist Mounting For New Construction
S13530	8" Round Commercial DL Trim; Clear/White Finish
S13531	8" Round Commercial DL Trim; Clear Finish
S13532	8" Round Commercial DL Trim; Black Finish
S13542	8" Round Goof Ring for Commercial Downlights; White Finish

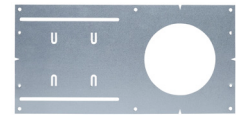

Asymmetric Mounting Plate



Hanger Bar Kit

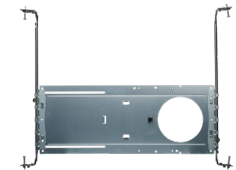

Mounting Plate with Hanger Bars



Mounting Plate for Stud/Joist



Clear/White Commercial Trim



Clear Commercial Trim



Black Commercial Trim

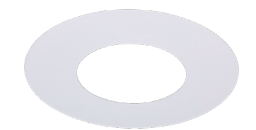

Goof Ring

**ACCESSORIES ASSOCIATED WITH ALL SKUS**

Item	Description
80-867	Universal Mounting Plate For New Construction
80-959	Rough-In Mounting Plate For 4/6/8 Or 10 Inch
80-985	6 Foot Remote Driver 3-Pin Ext

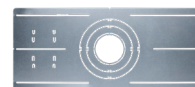

80-867

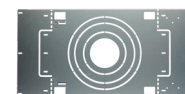

80-959



80-985

**PHOTOMETRICS**

**SATCO Item: S13510**

Description: 12WLED/CDL/4/RD/FS/RND  
 Default PowerQuick Setting: 12W  
 Default ColorQuick Setting: 3000K  
 1113 LM, 11.01 W, 101 LPW  
 Beam Angle: 83°  
 Field Angle: 130°  
 Spacing Criteria (0°-180°): 1.09  
 Spacing Criteria (90°-270°): 1.11

Candela Polar Plot			Zonal Lumens			Illumination at Distance		
Zone	Lumens	%Luminaire	Distance	Center Beam	Beam Spread			
0-30°	447	40.2%	4ft	38fc	7.0ft			
0-40°	689	61.9%	6ft	17fc	10.5ft			
0-60°	1008	90.6%	8ft	10fc	14.0ft			
0-90°	1113	100.0%	10ft	6fc	17.5ft			
90-180°	0	0.0%	12ft	4fc	21.0ft			
0-180°	1113	100.0%						

**Lumen Multipliers**

2700K	3000K	3500K	4000K	5000K	6W	9W	12W
0.95	1.00	1.04	1.05	1.00	0.55	0.81	1.00

*Max Candela = 611*

**SATCO Item: S13511**

Description: 24WLED/CDL/6/RD/FS/RND  
 Default PowerQuick Setting: 24W  
 Default ColorQuick Setting: 3000K  
 2154 LM, 22.05 W, 98 LPW  
 Beam Angle: 89°  
 Field Angle: 128°  
 Spacing Criteria (0°-180°): 1.13  
 Spacing Criteria (90°-270°): 1.13

Candela Polar Plot			Zonal Lumens			Illumination at Distance		
Zone	Lumens	%Luminaire	Distance	Center Beam	Beam Spread			
0-30°	835	38.7%	4ft	71fc	7.9ft			
0-40°	1310	60.8%	6ft	32fc	11.8ft			
0-60°	2006	93.1%	8ft	18fc	15.7ft			
0-90°	2154	100.0%	10ft	11fc	19.7ft			
90-180°	0	0.0%	12ft	8fc	23.6ft			
0-180°	2154	100.0%						

**Lumen Multipliers**

2700K	3000K	3500K	4000K	5000K	12W	16W	24W
0.93	1.00	1.05	1.05	0.98	0.58	0.76	1.00

*Max Candela = 1136*

**SATCO Item: S13512**

Description: 30WLED/CDL/8/RD/FS/RND  
 Default PowerQuick Setting: 30W  
 Default ColorQuick Setting: 3000K  
 2718 LM, 26.66 W, 102 LPW  
 Beam Angle: 89°  
 Field Angle: 127°  
 Spacing Criteria (0°-180°): 1.14  
 Spacing Criteria (90°-270°): 1.14

Candela Polar Plot			Zonal Lumens			Illumination at Distance		
Zone	Lumens	%Luminaire	Distance	Center Beam	Beam Spread			
0-30°	1059	39.0%	4ft	90fc	7.8ft			
0-40°	1672	61.5%	6ft	40fc	11.7ft			
0-60°	2522	92.8%	8ft	23fc	15.6ft			
0-90°	2718	100.0%	10ft	14fc	19.6ft			
90-180°	0	0.0%	12ft	10fc	23.5ft			
0-180°	2718	100.0%						

**Lumen Multipliers**

2700K	3000K	3500K	4000K	5000K	16W	22W	30W
0.93	1.00	1.05	1.05	0.99	0.60	0.82	1.00

*Max Candela = 1439*